

ICF WALL LAYOUT - SECTION 1
 SCALE: 1/16"=1'-0"
 SDR: A12

ONCE REBAR SERVICES

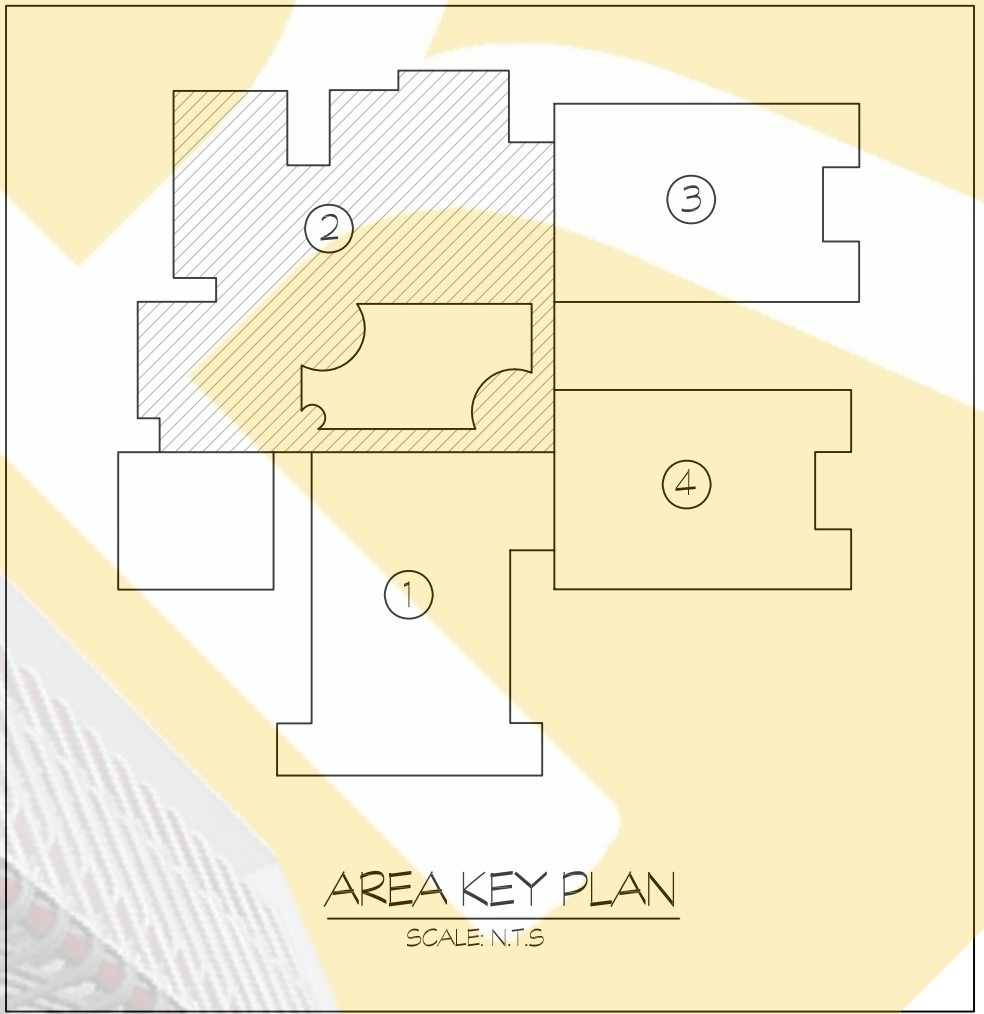
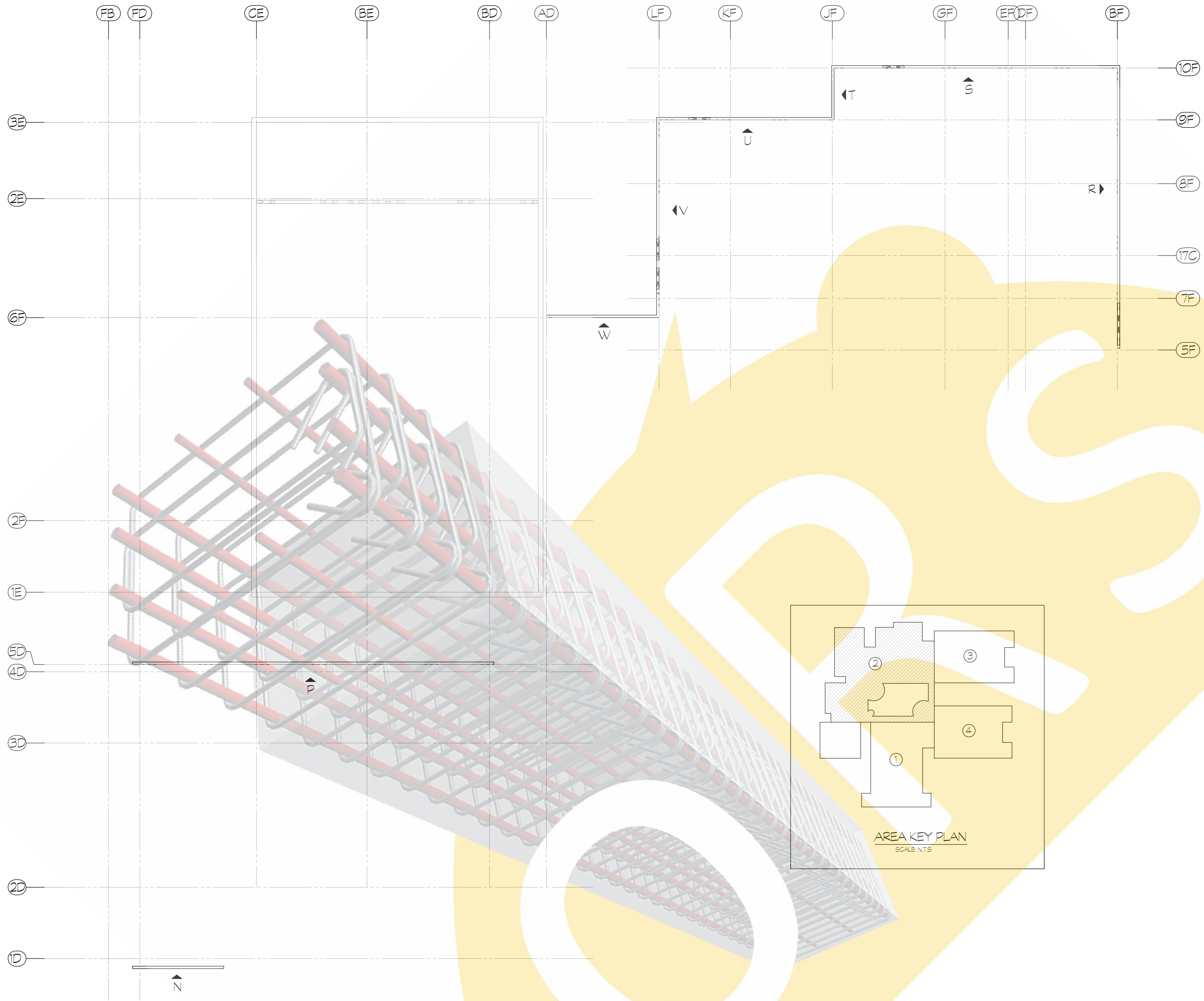

ICF WALL LAYOUT - SECTION 2
 SCALE: 1/10"=1'-0"
 SDR: A13

ONCE REBAR SERVICES

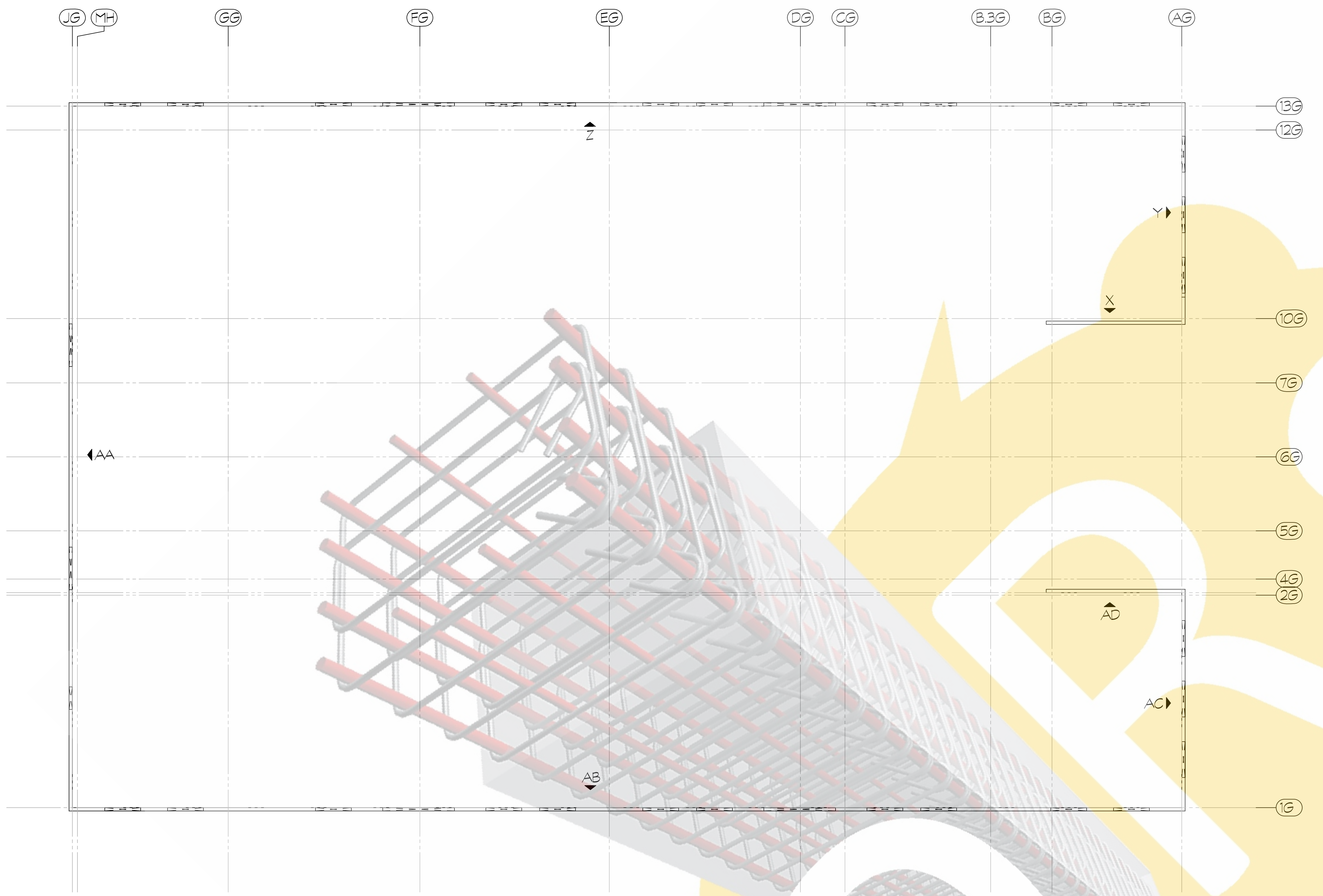

ICF WALL LAYOUT - SECTION 3
 SCALE: 1/8"=1'-0"
 SDR: A1.4

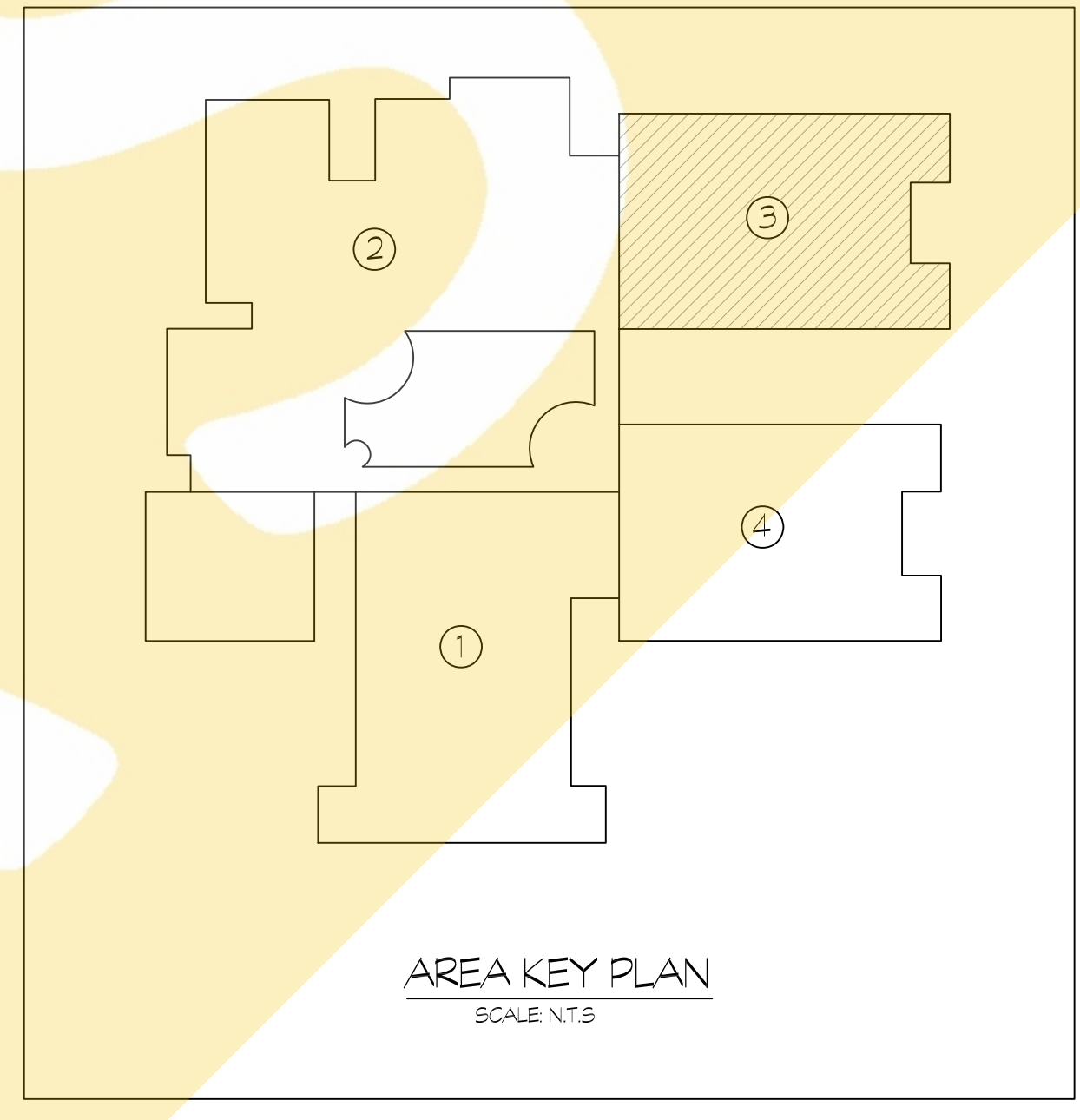

ONCE REBAR SERVICES

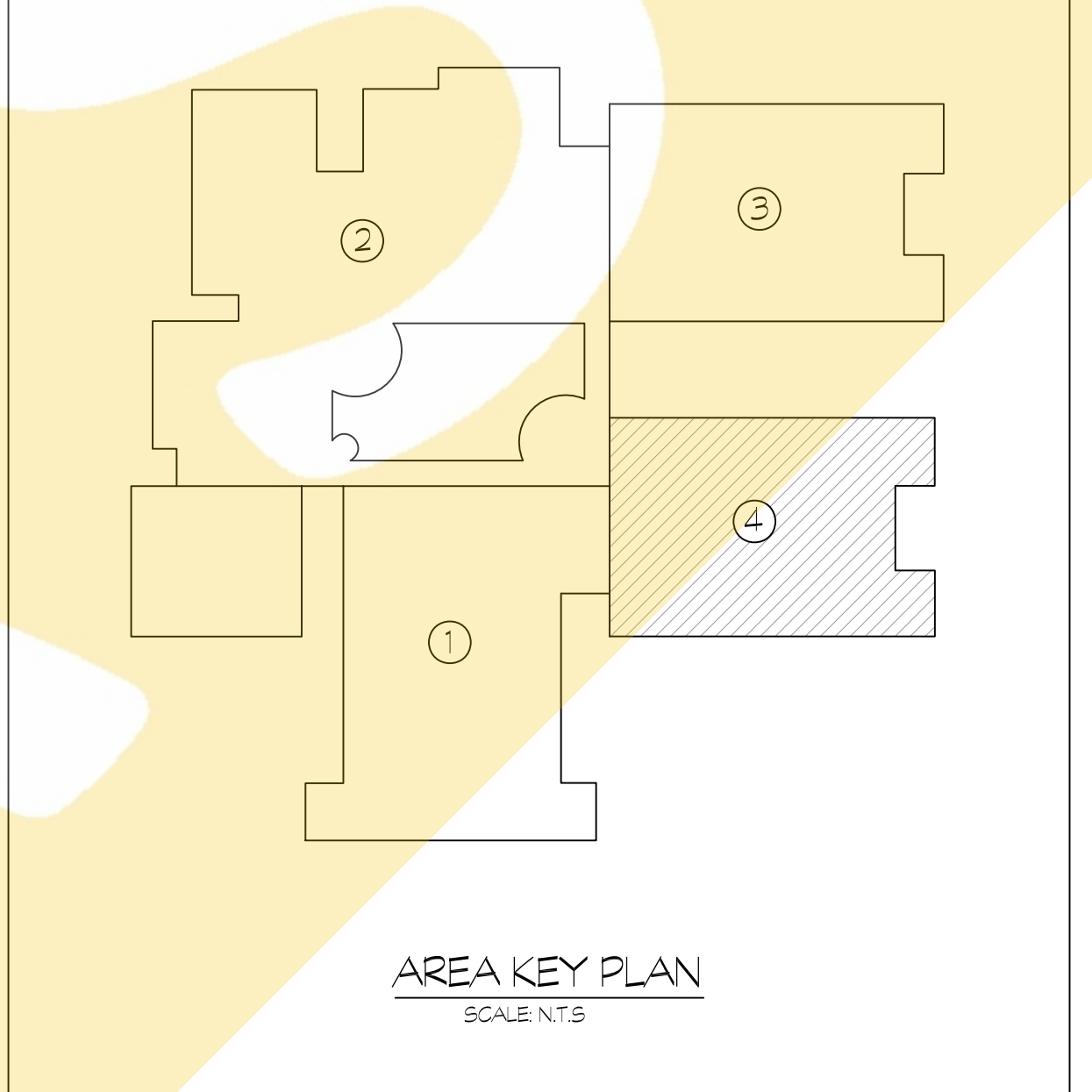
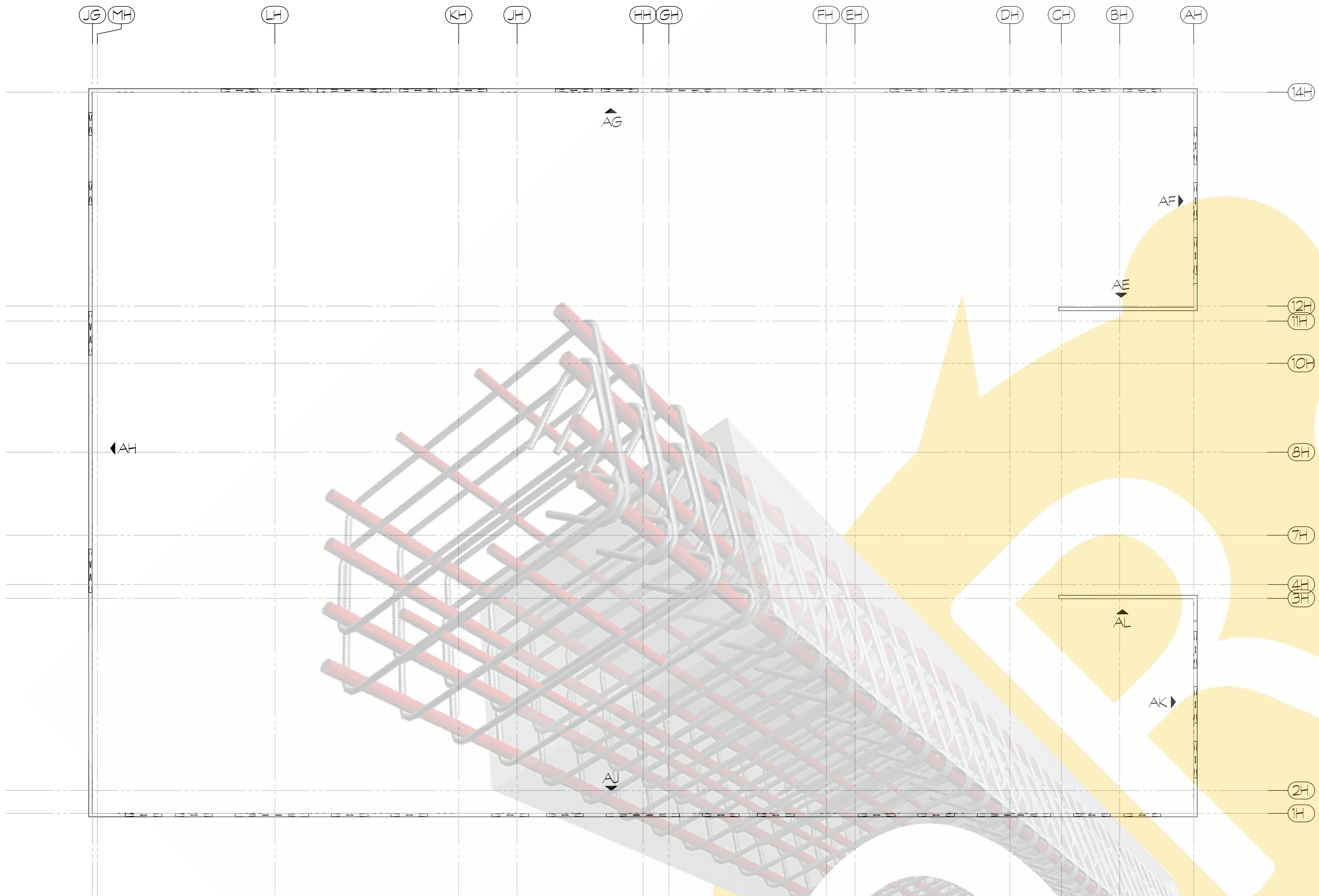

ICF WALL LAYOUT - SECTION 4
 SCALE 1/8"=1'-0"
 SDR A1.5



ONCE REBAR SERVICES

ONCE REBAR SERVICES

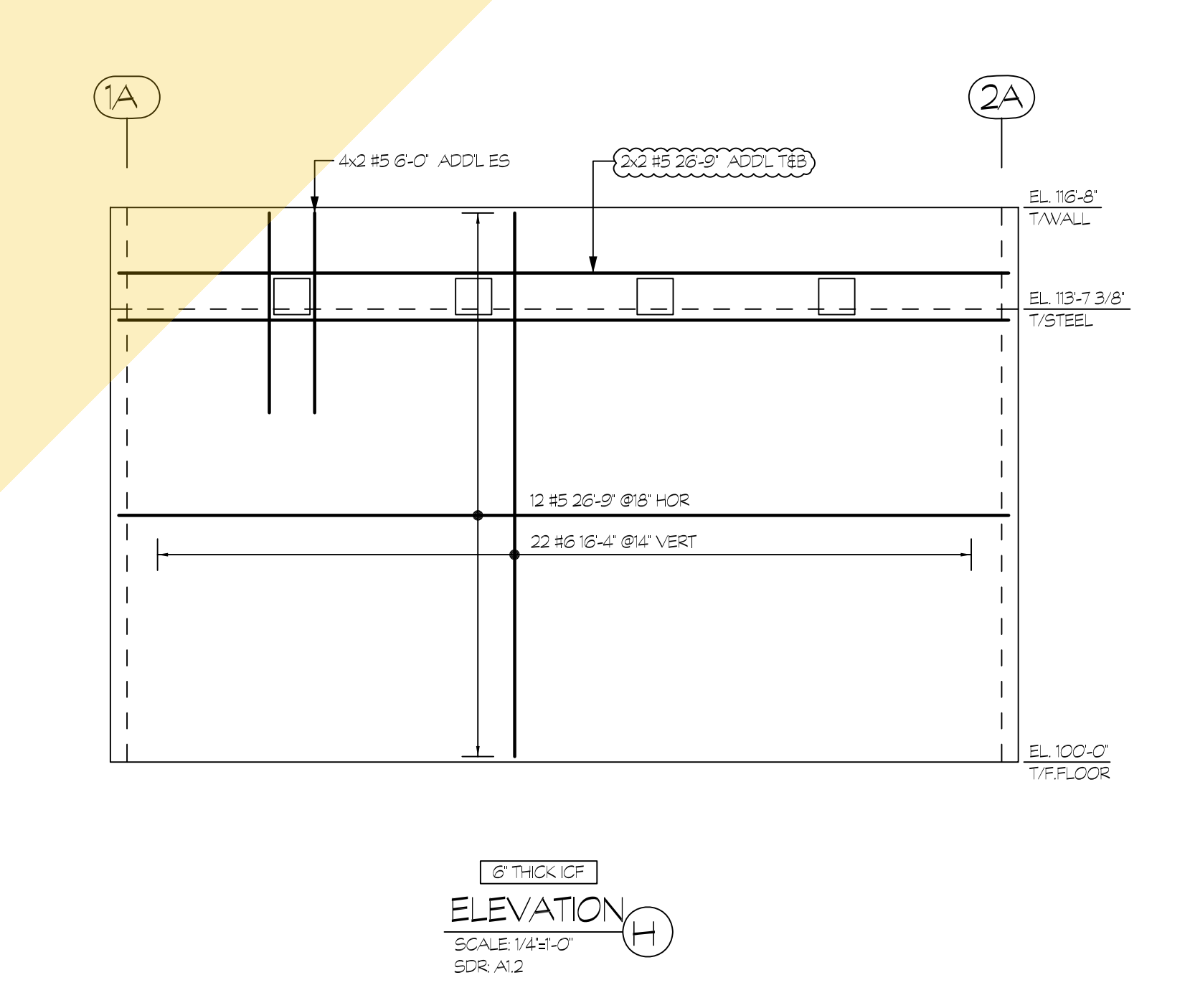
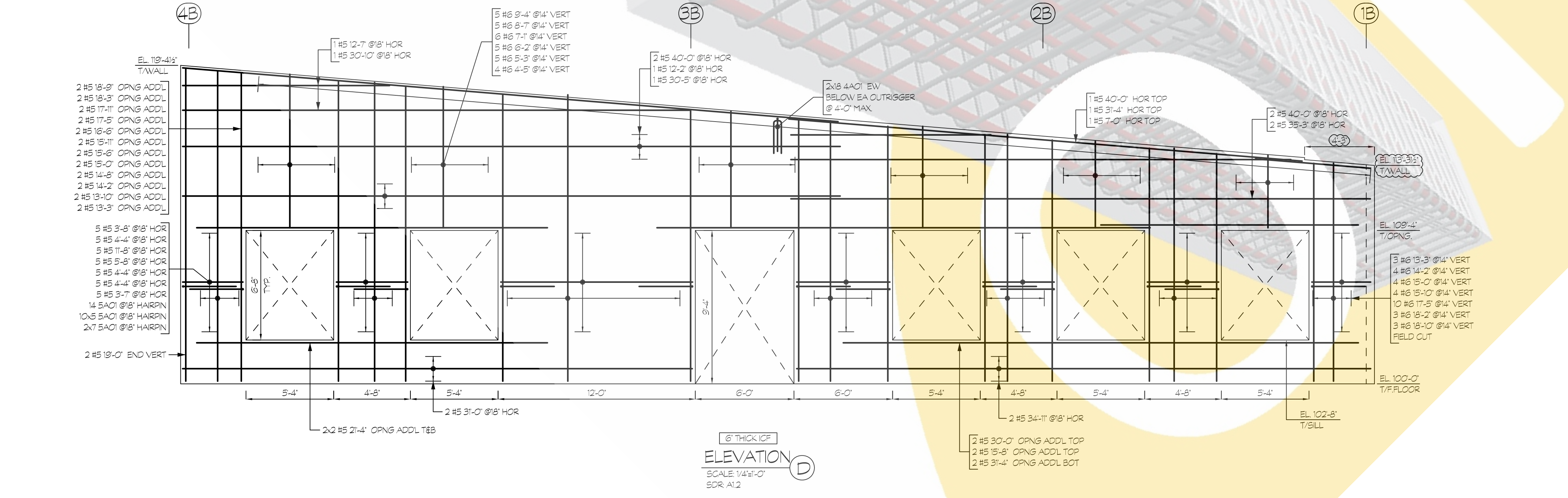
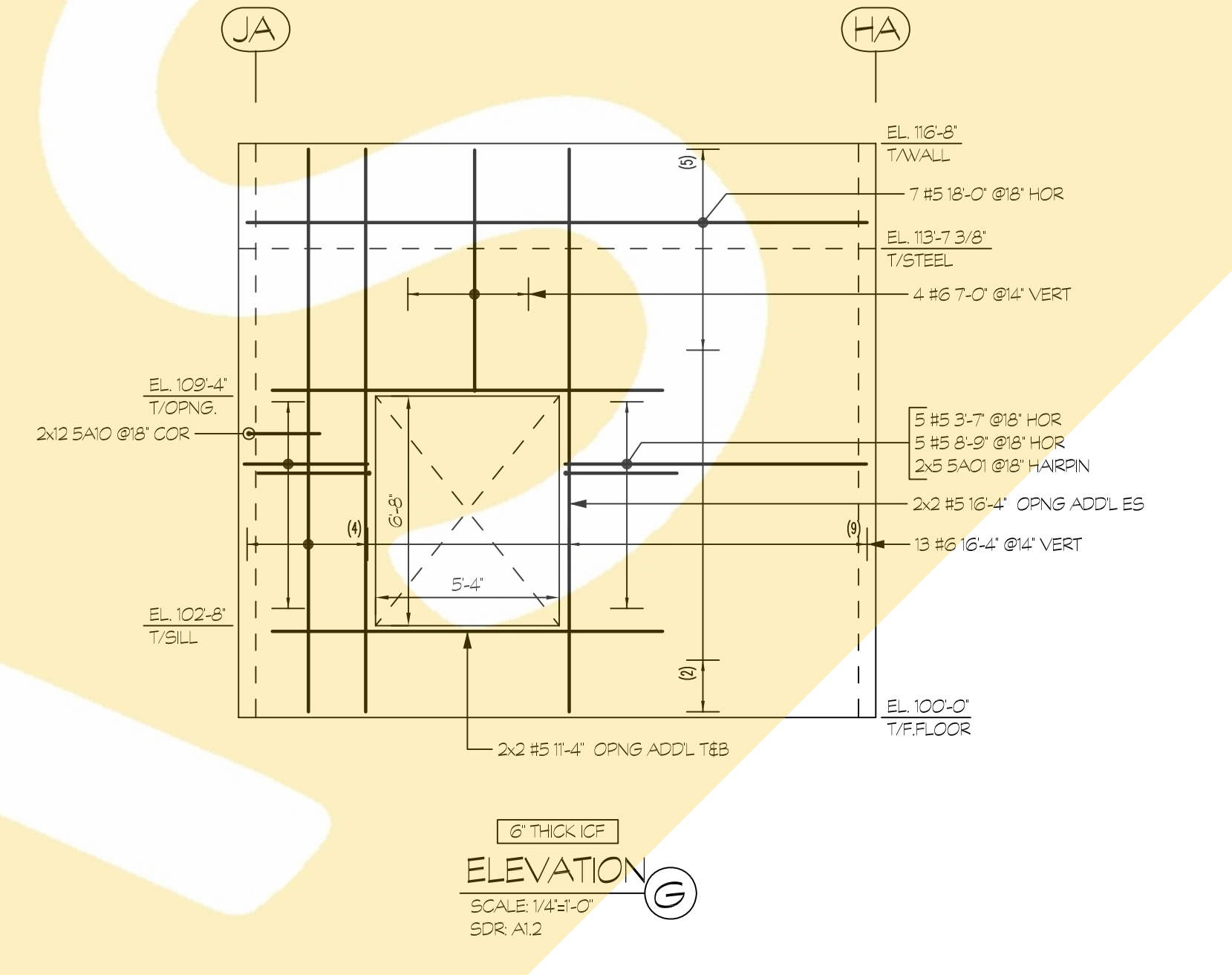
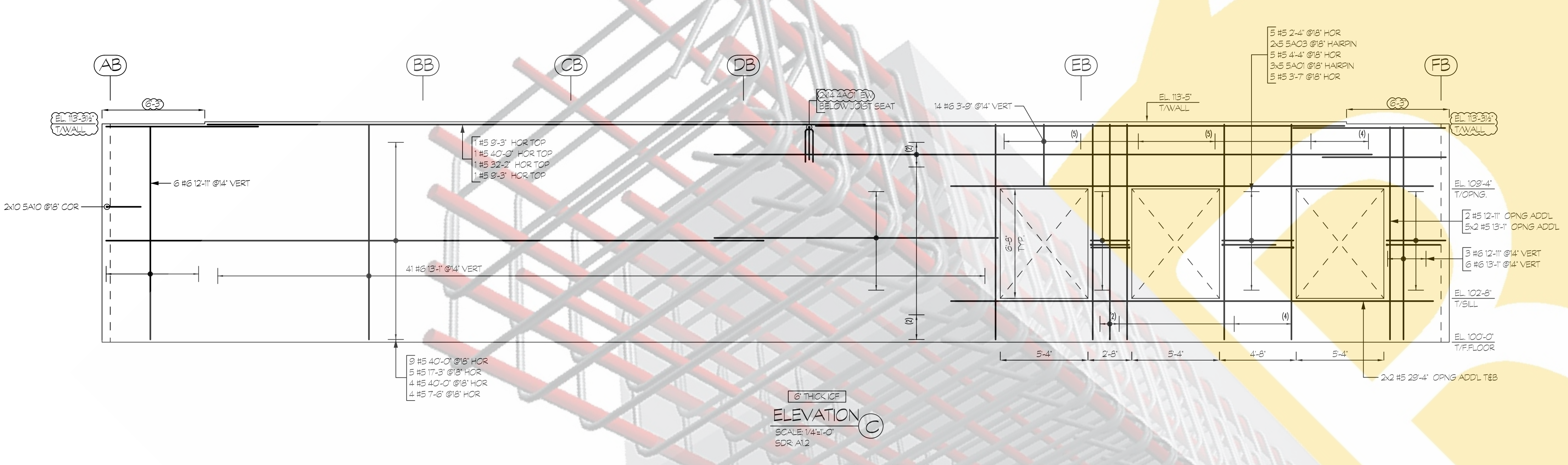
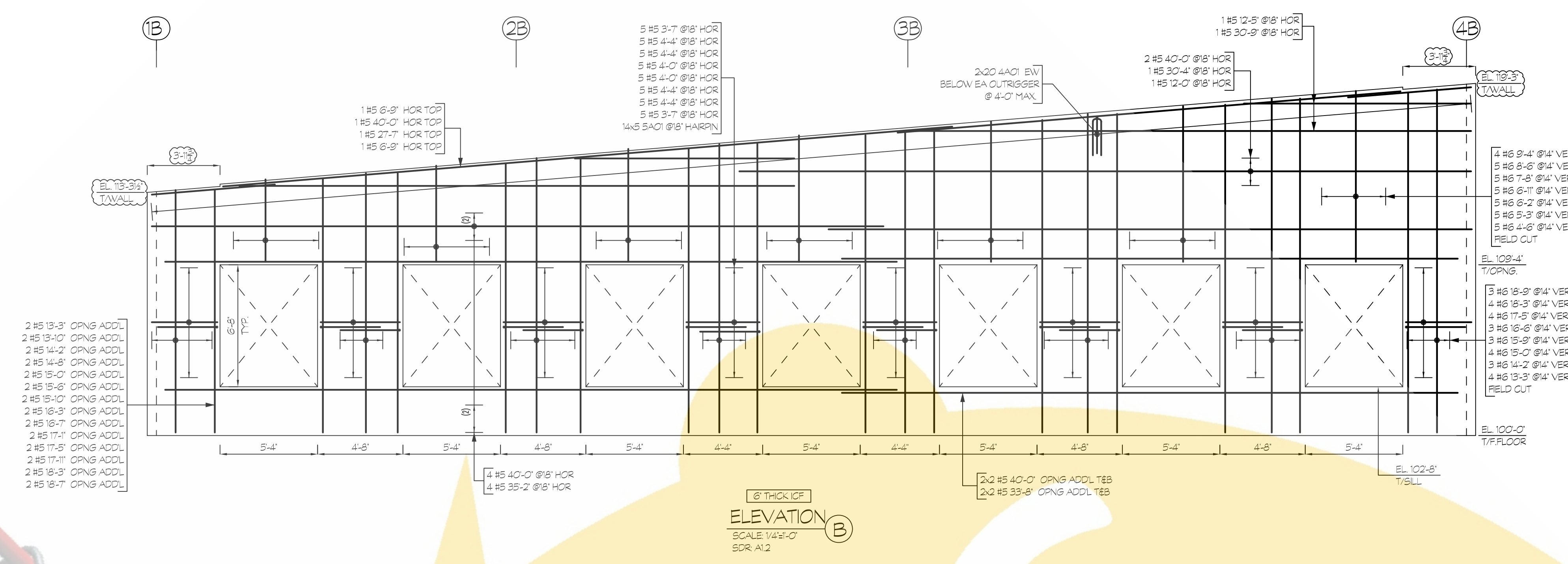
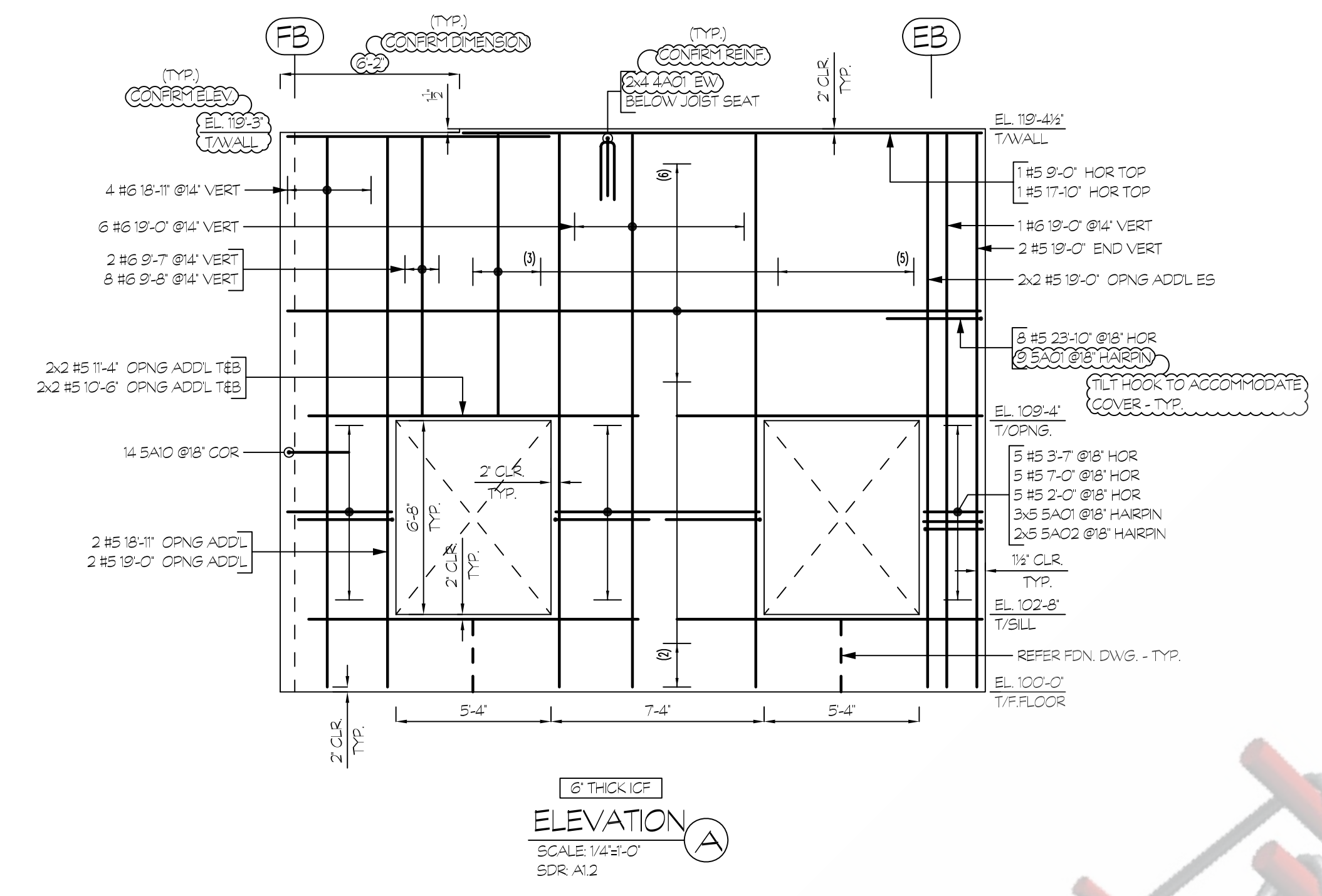

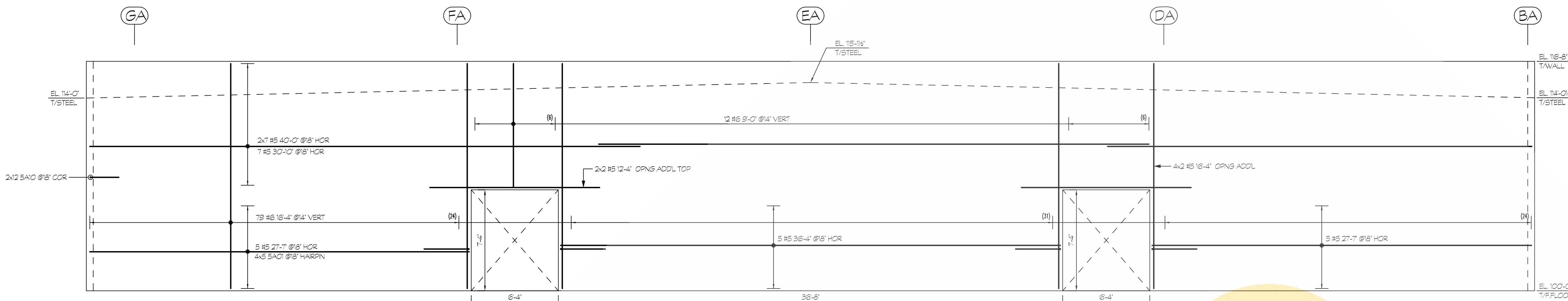

6" THICK ICF
ELEVATION E
SCALE 1/4"=1'-0"
SDR A12

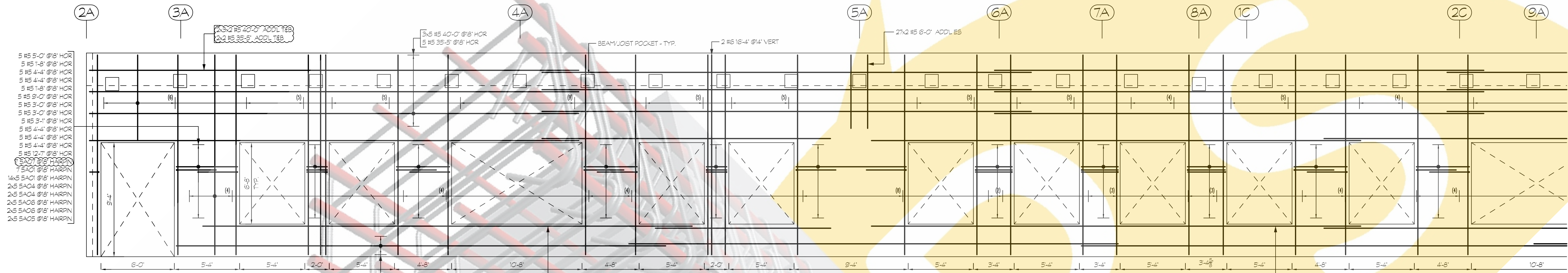

6" THICK ICF
ELEVATION F
SCALE 1/4"=1'-0"
SDR A12

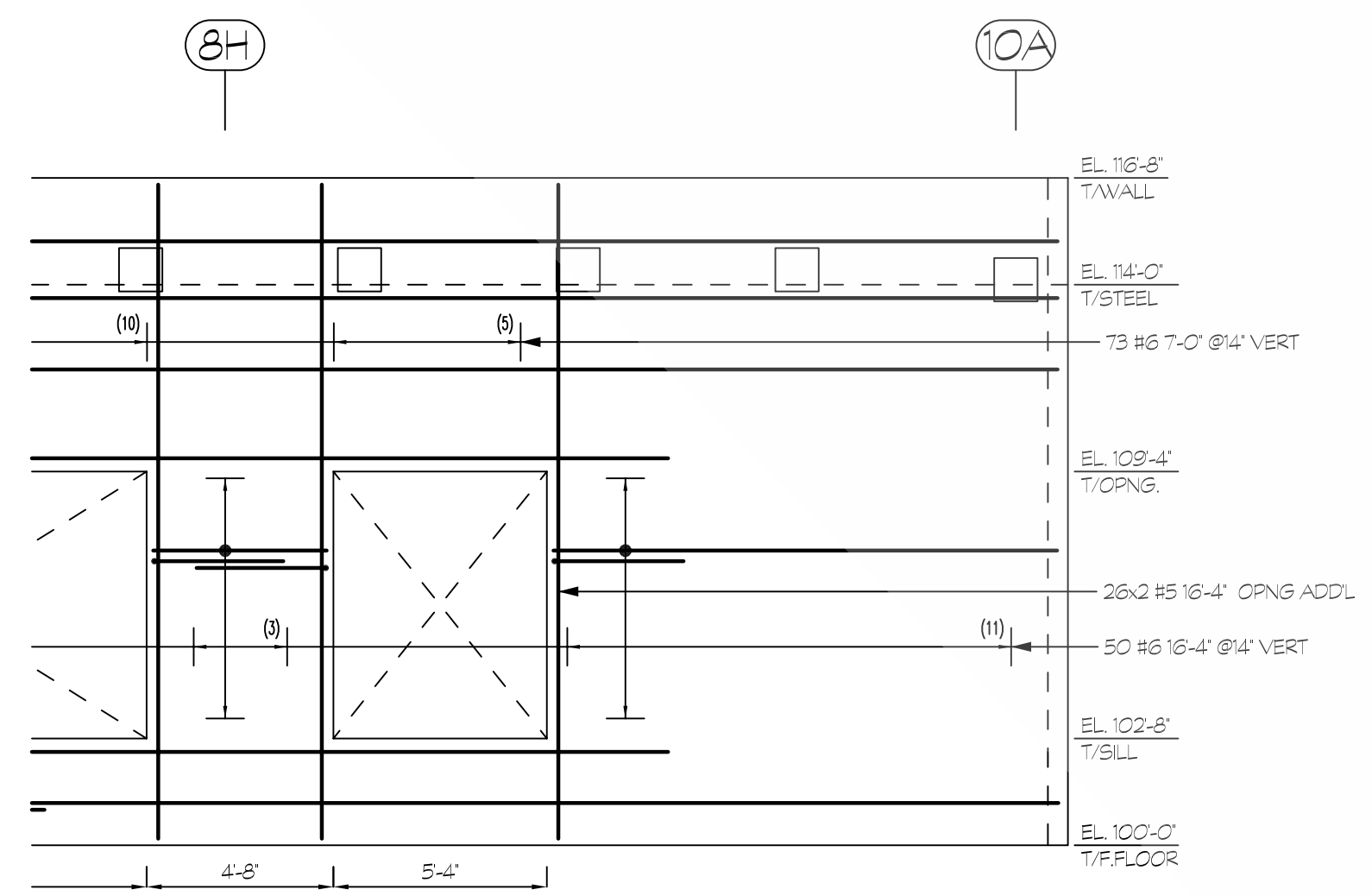

6" THICK ICF
ELEVATION G
SCALE 1/4"=1'-0"
SDR A12

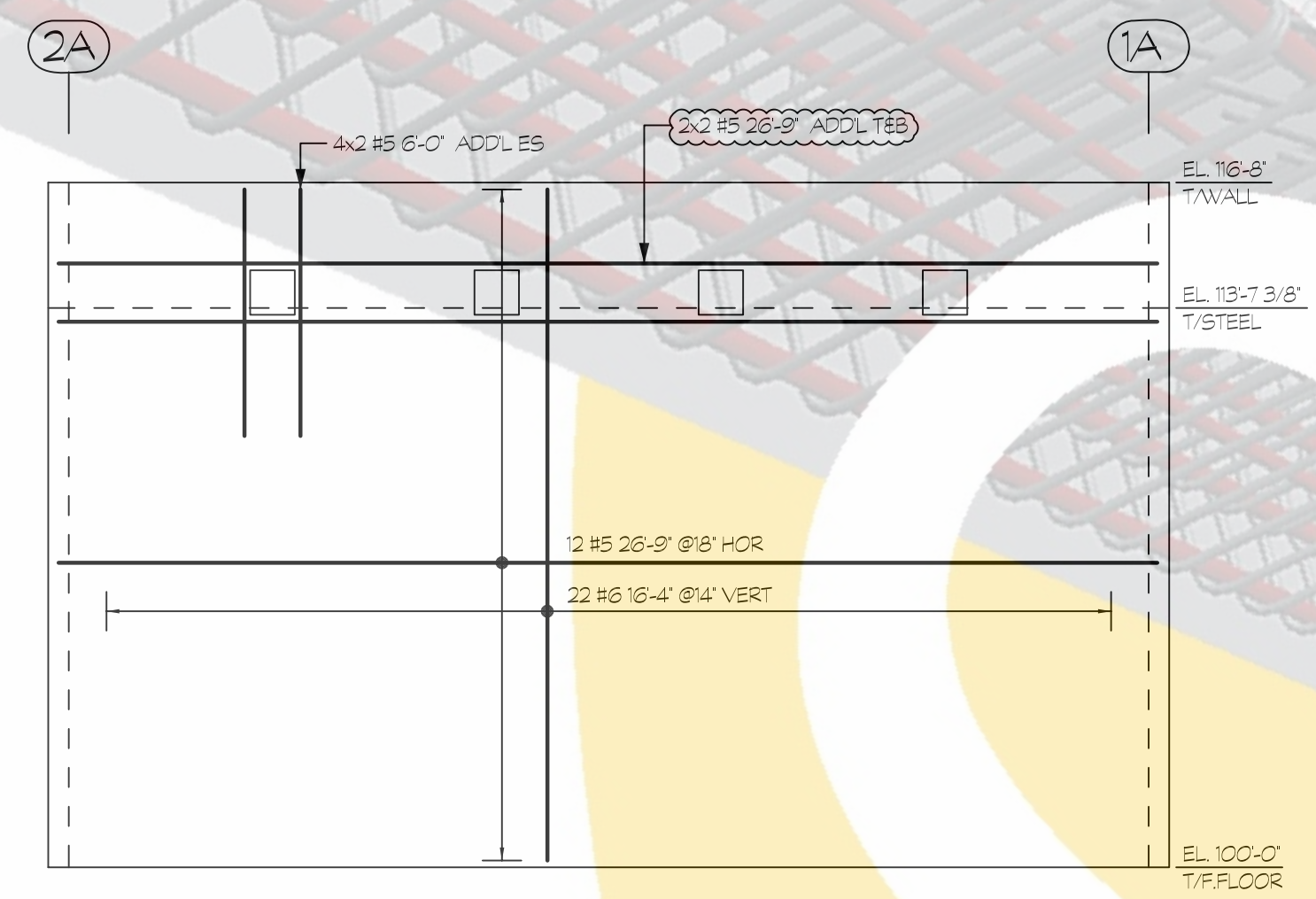

6" THICK ICF
ELEVATION H
SCALE 1/4"=1'-0"
SDR A12

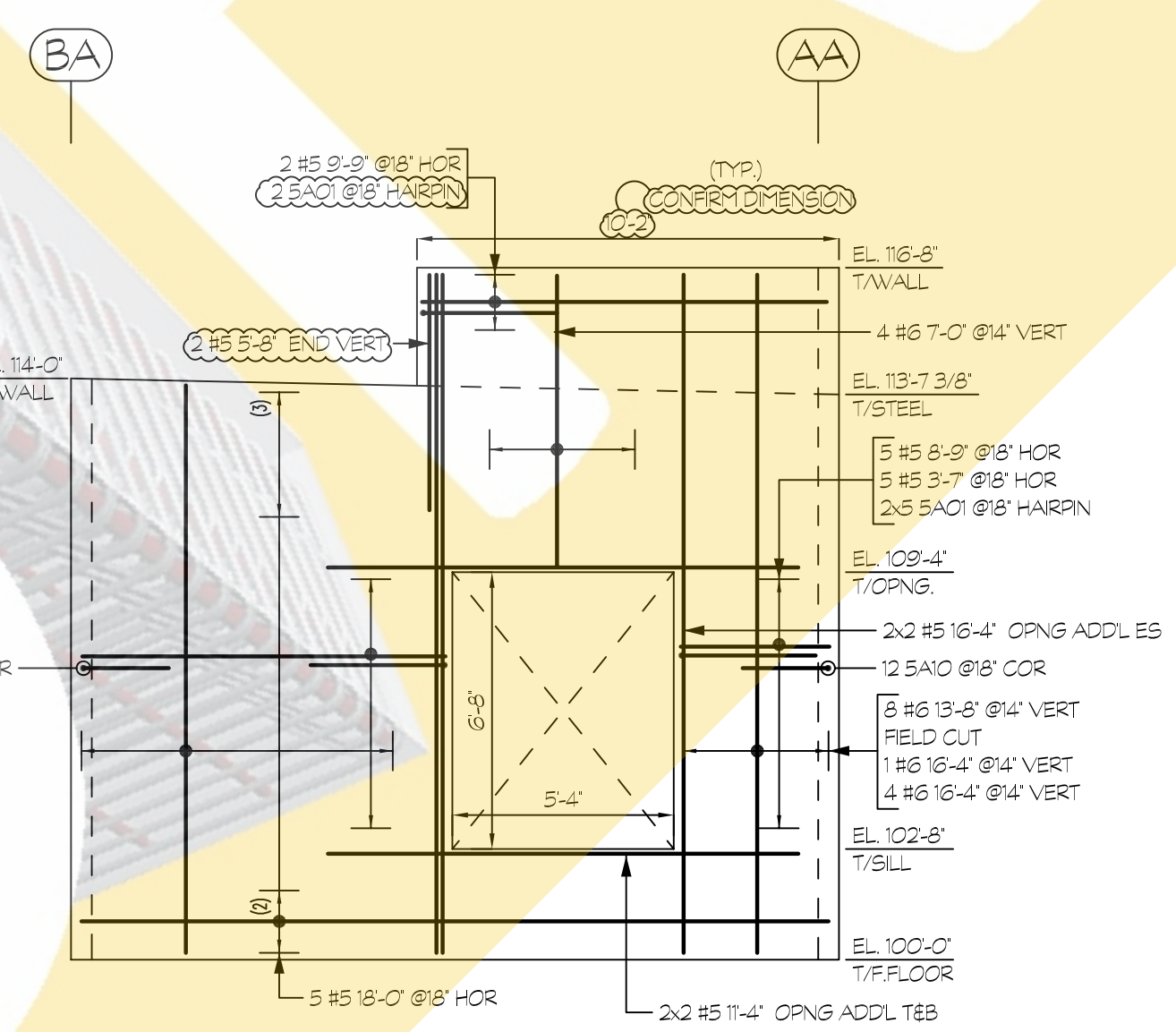

6" THICK ICF
ELEVATION I
SCALE 1/4"=1'-0"
SDR A12

ONCE REBAR SERVICES

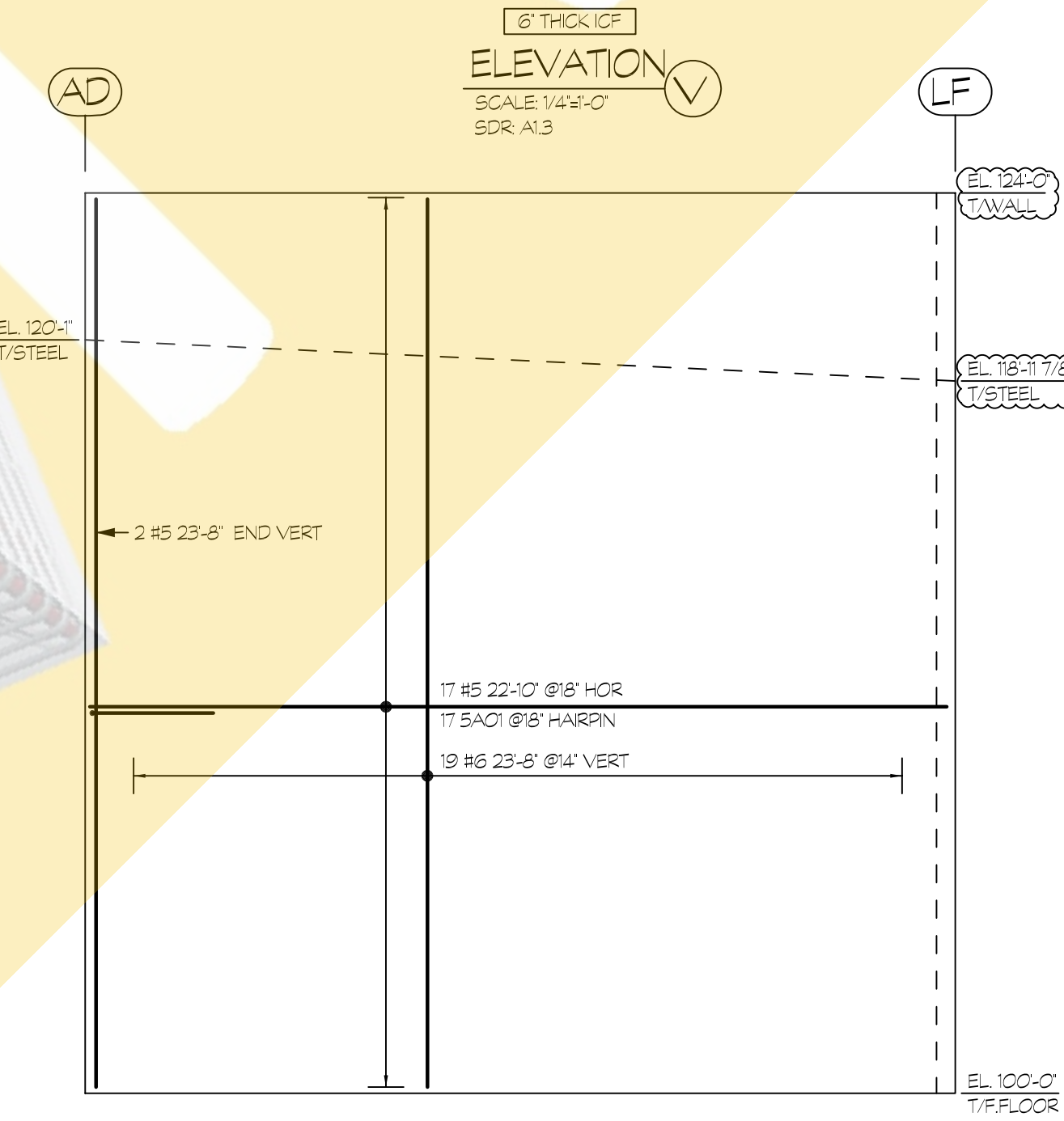
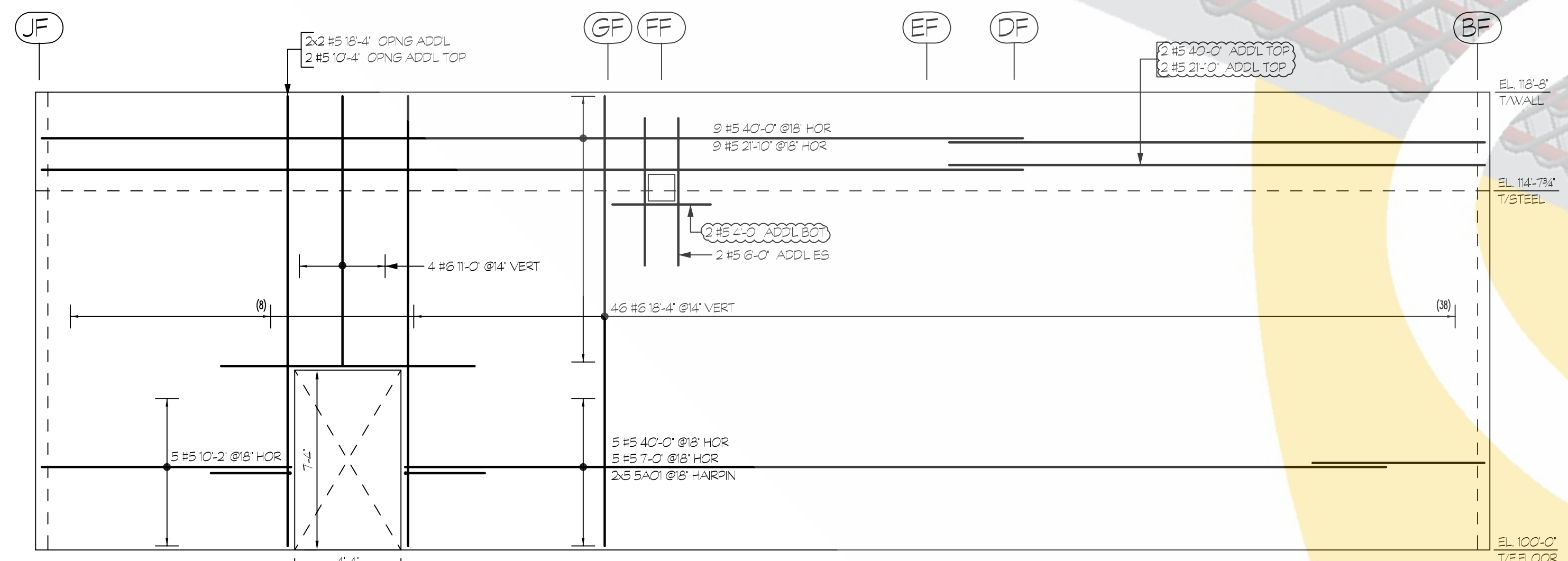
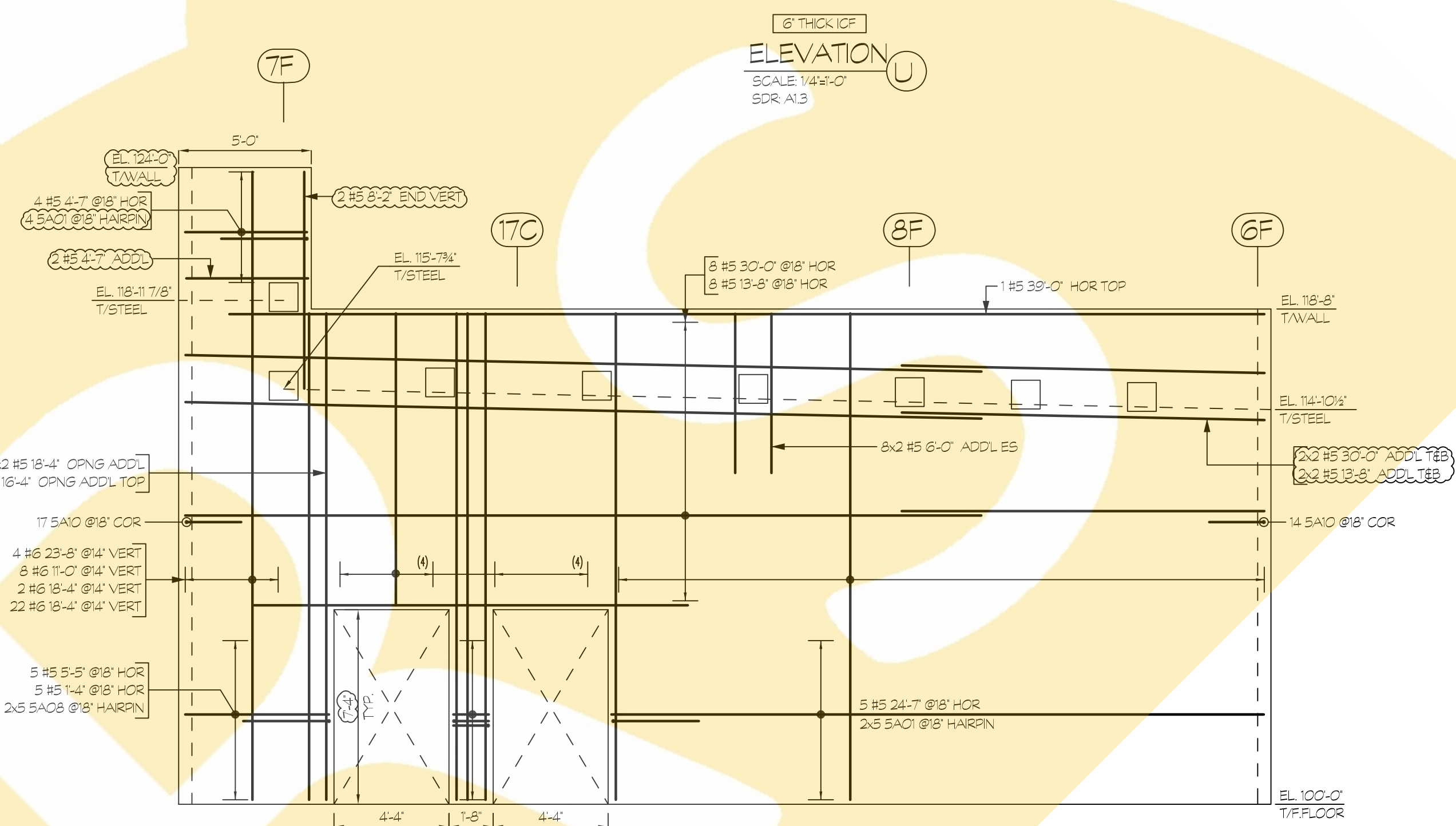
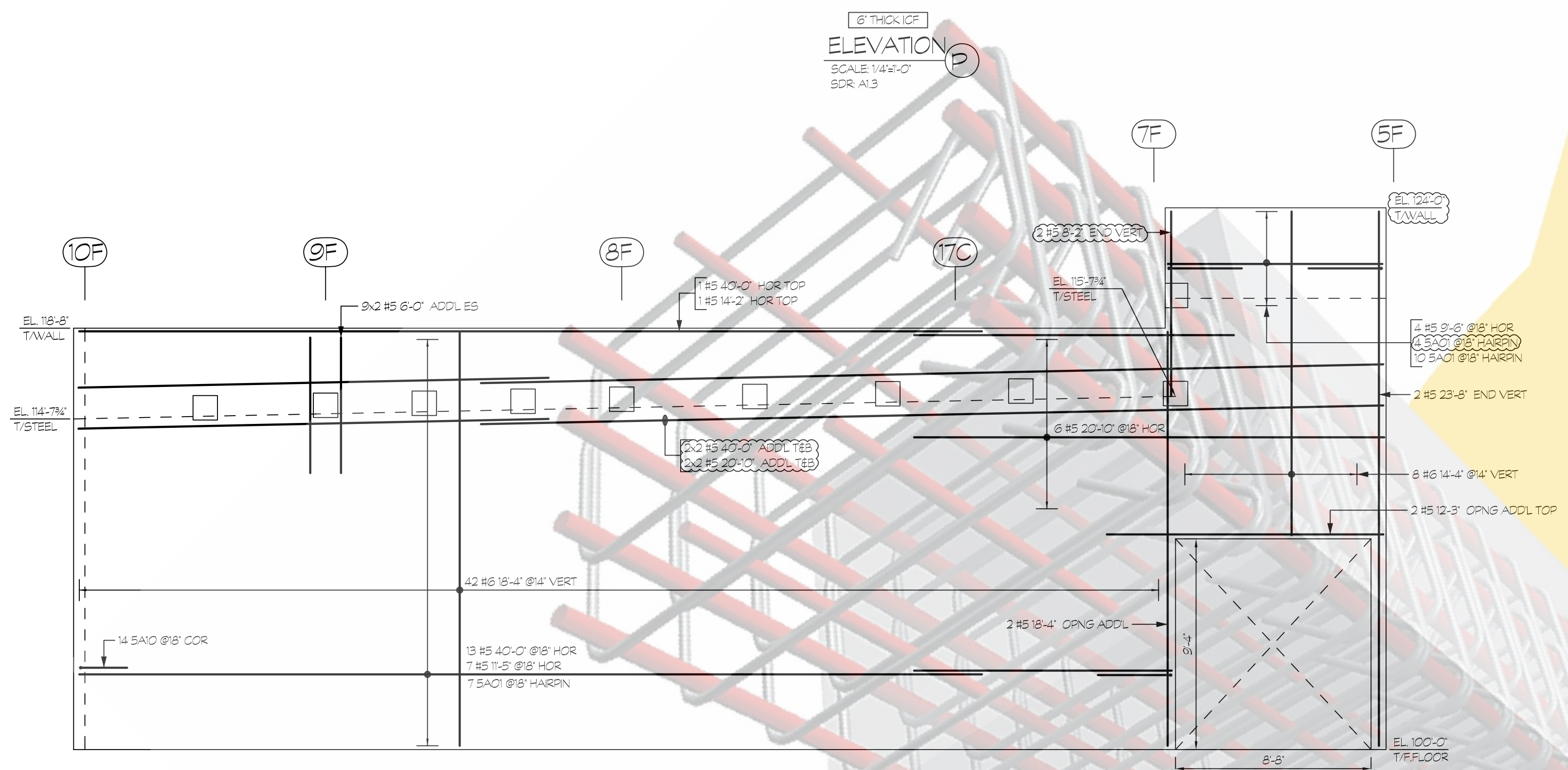
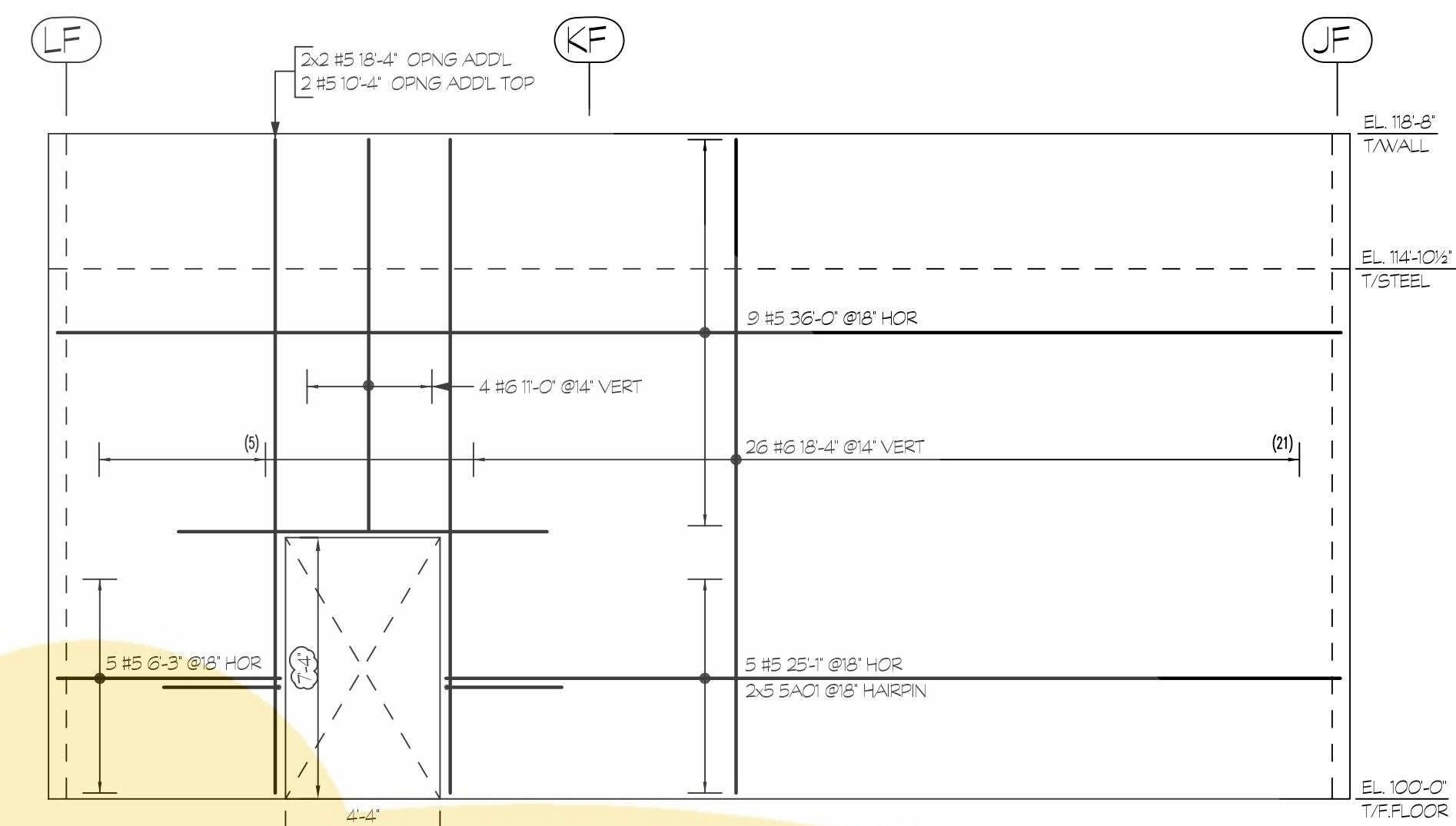
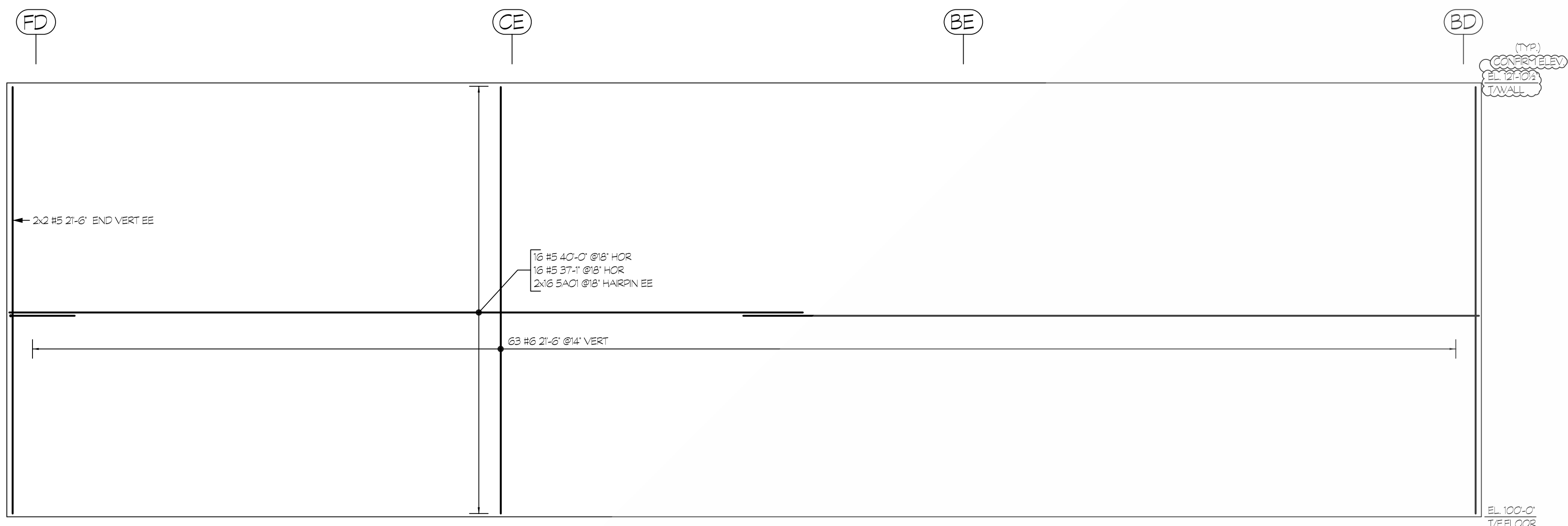

8" THICK ICF
ELEVATION P
SCALE: 1/4"=1'-0"
SDR A1.3

8" THICK ICF
ELEVATION U
SCALE: 1/4"=1'-0"
SDR A1.3

8" THICK ICF
ELEVATION R
SCALE: 1/4"=1'-0"
SDR A1.3

8" THICK ICF
ELEVATION V
SCALE: 1/4"=1'-0"
SDR A1.3

8" THICK ICF
ELEVATION S
SCALE: 1/4"=1'-0"
SDR A1.3

8" THICK ICF
ELEVATION W
SCALE: 1/4"=1'-0"
SDR A1.3

ONCE REBAR SERVICES

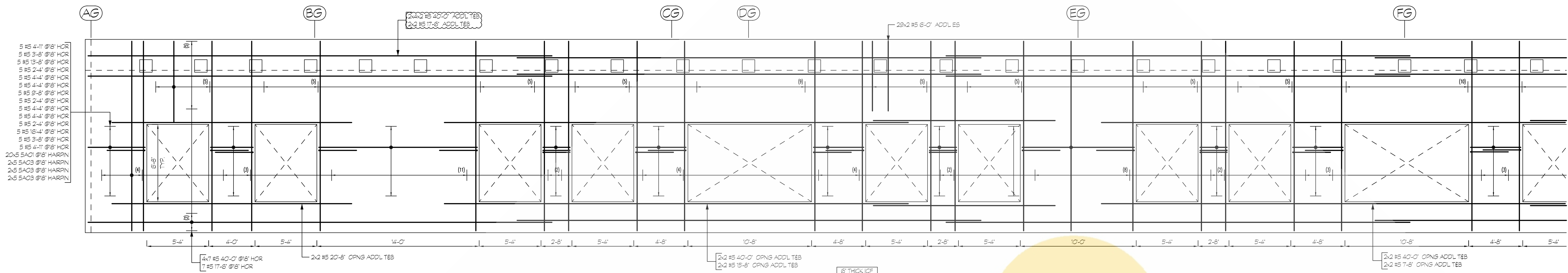

8" THICK ICF
ELEVATION AB
SCALE 1/4"=1'-0"
SDR A14

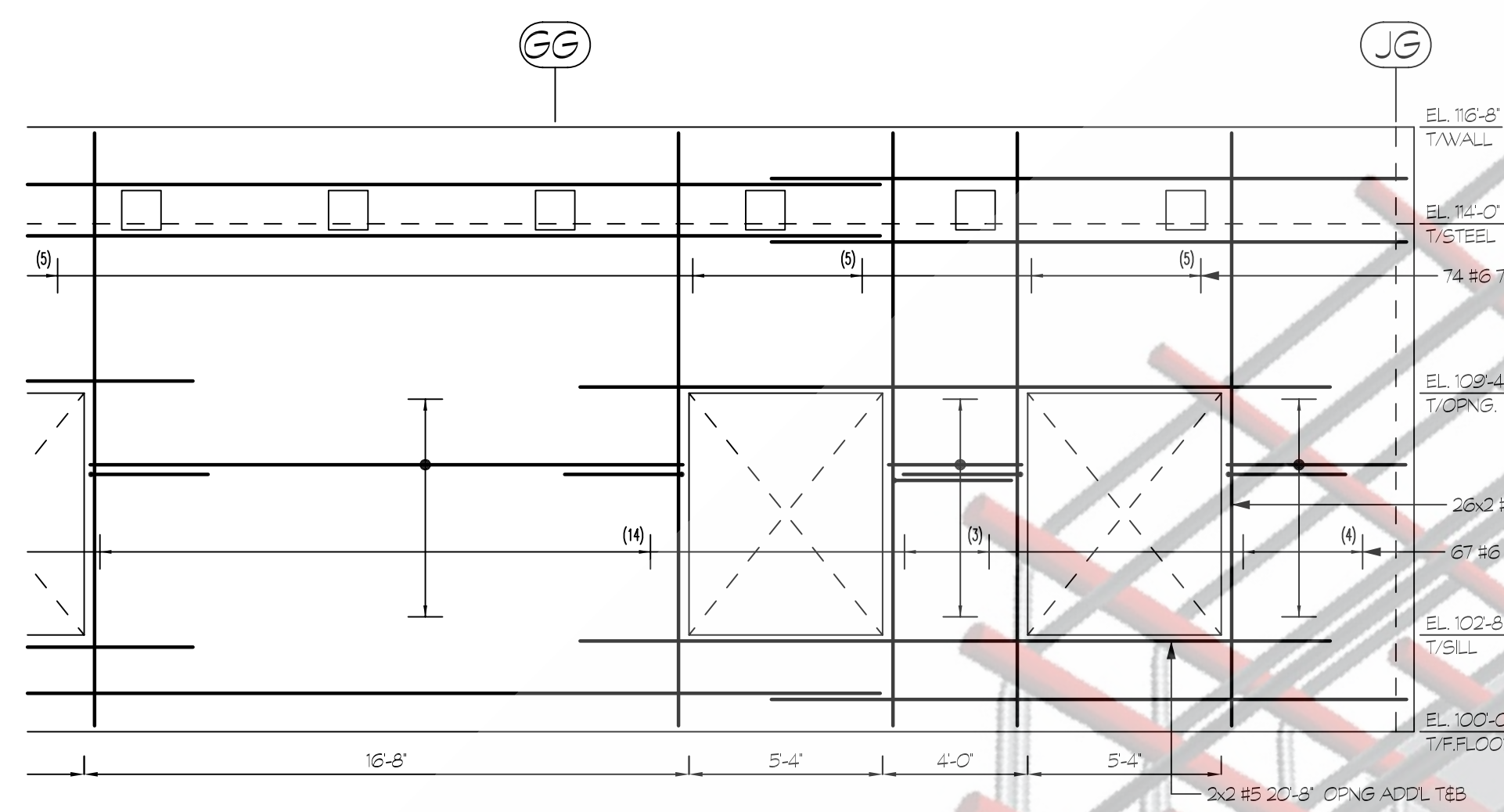

8" THICK ICF
ELEVATION AB
SCALE 1/4"=1'-0"
SDR A14

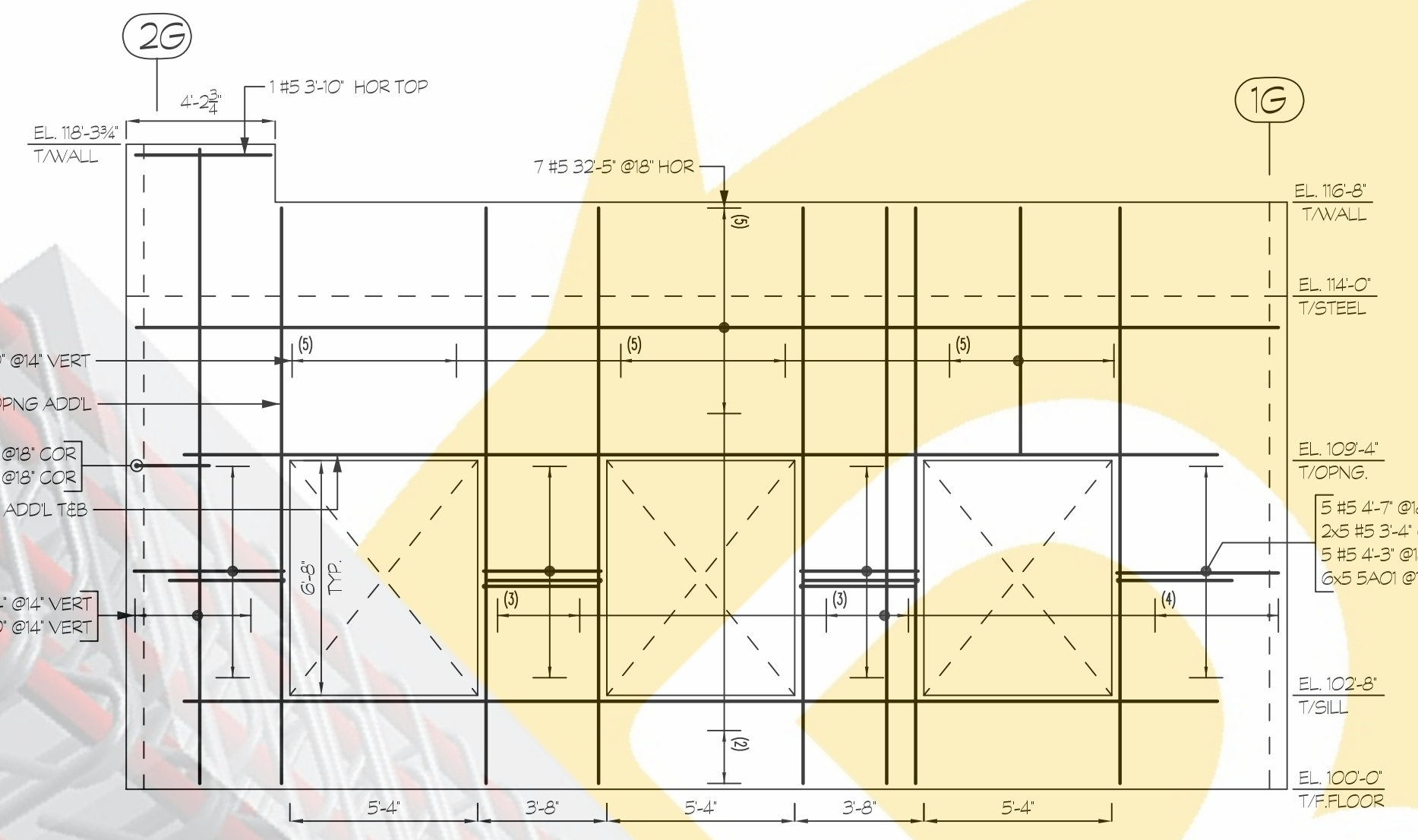

8" THICK ICF
ELEVATION AC
SCALE 1/4"=1'-0"
SDR A14

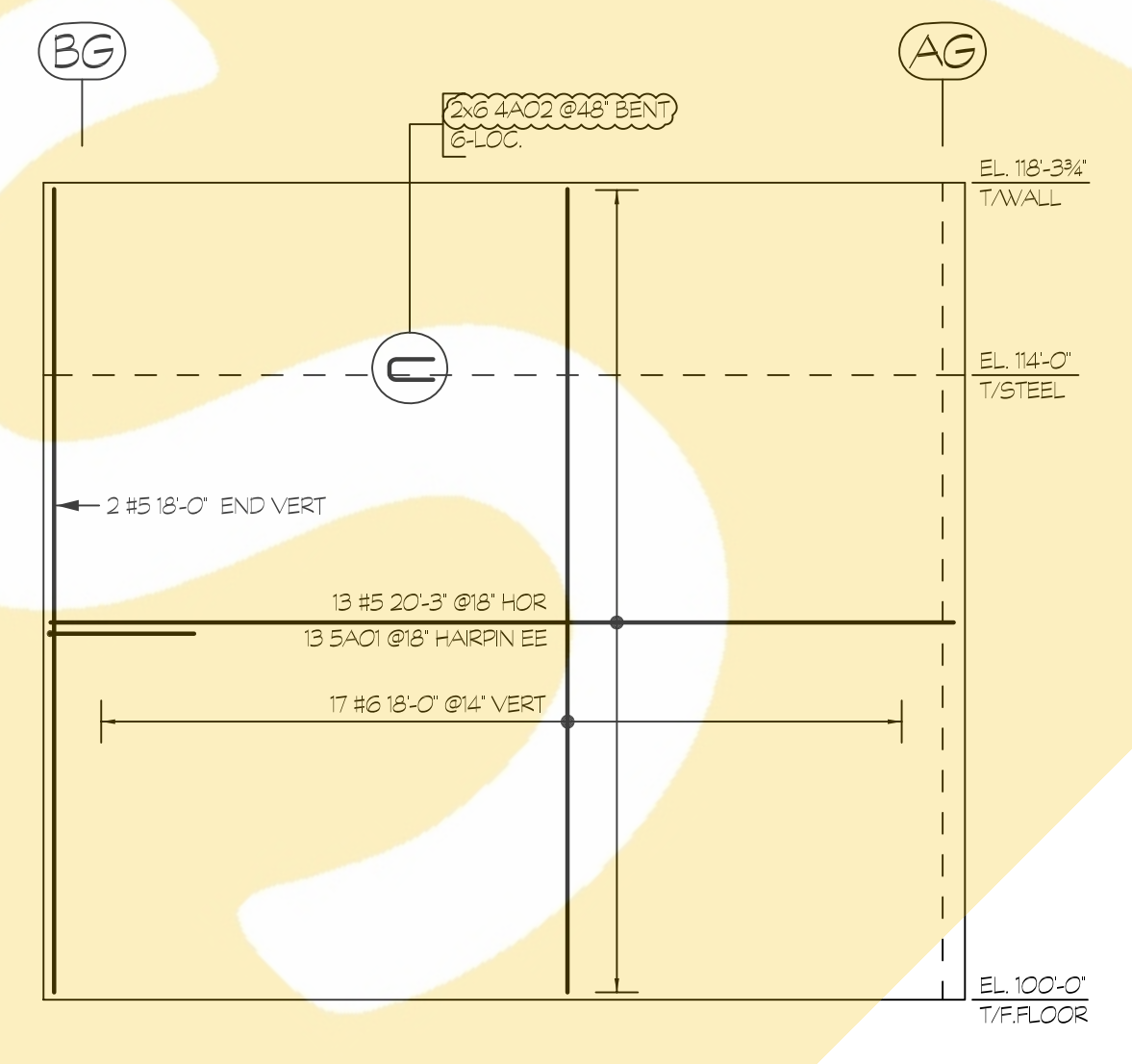

8" THICK ICF
ELEVATION AD
SCALE 1/4"=1'-0"
SDR A14

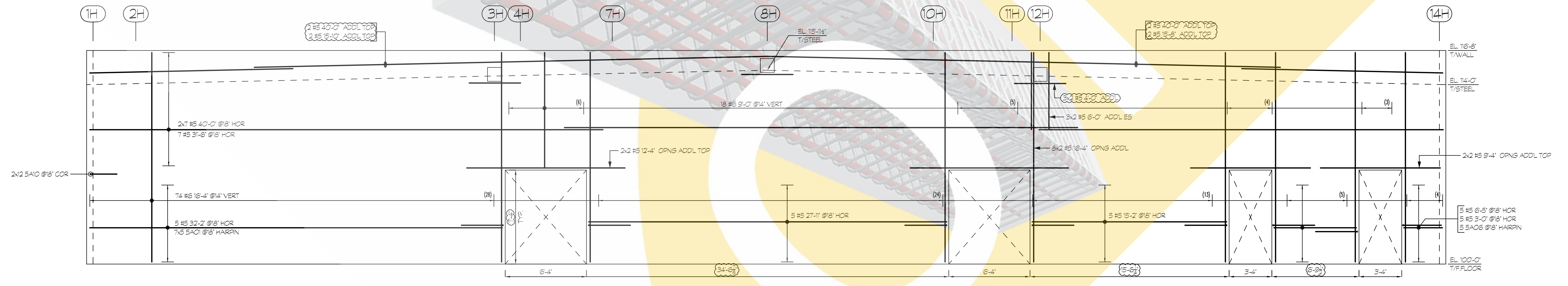

8" THICK ICF
ELEVATION AH
SCALE 1/4"=1'-0"
SDR A15

ONCE REBAR SERVICES

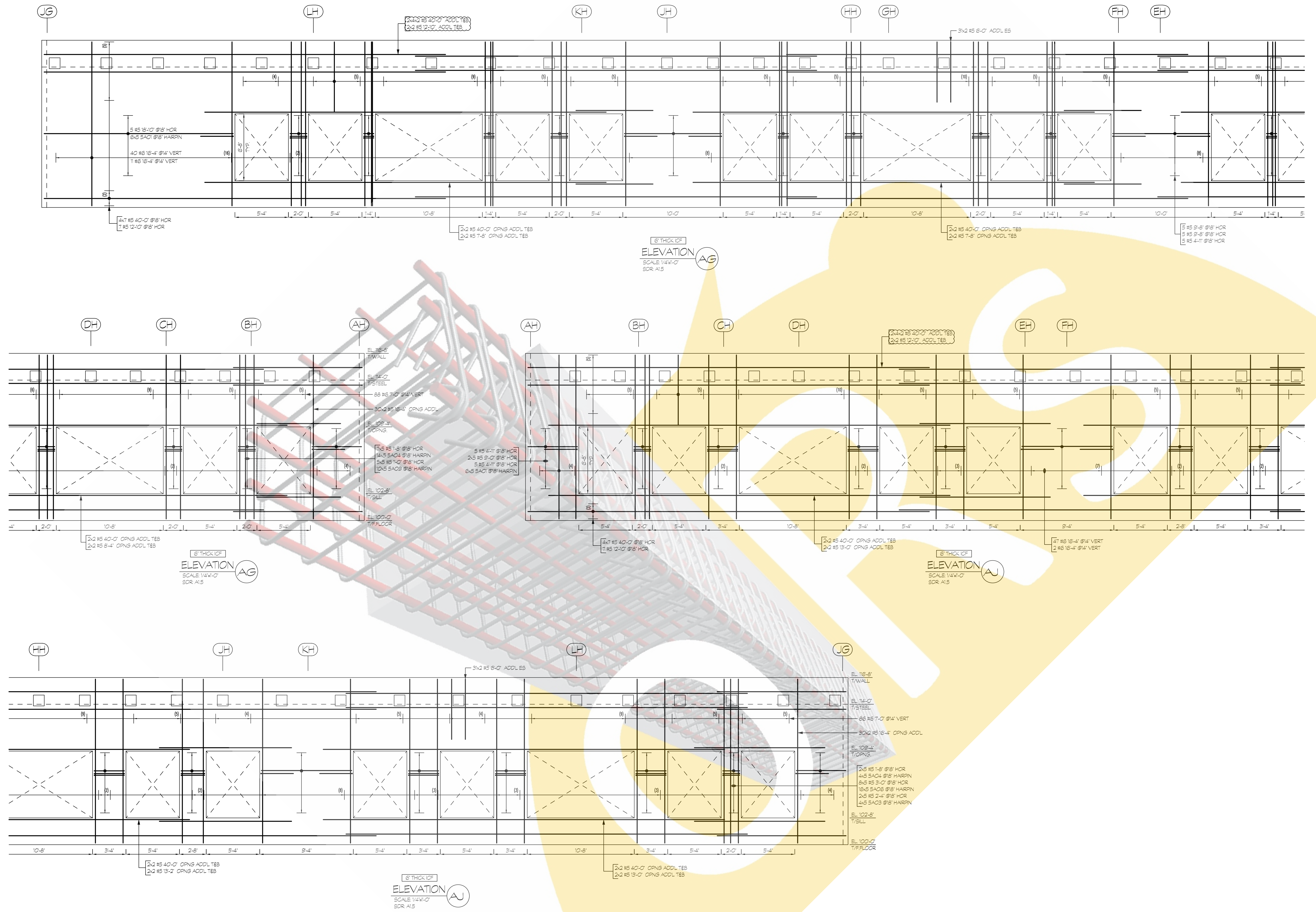

ONCE REBAR SERVICES

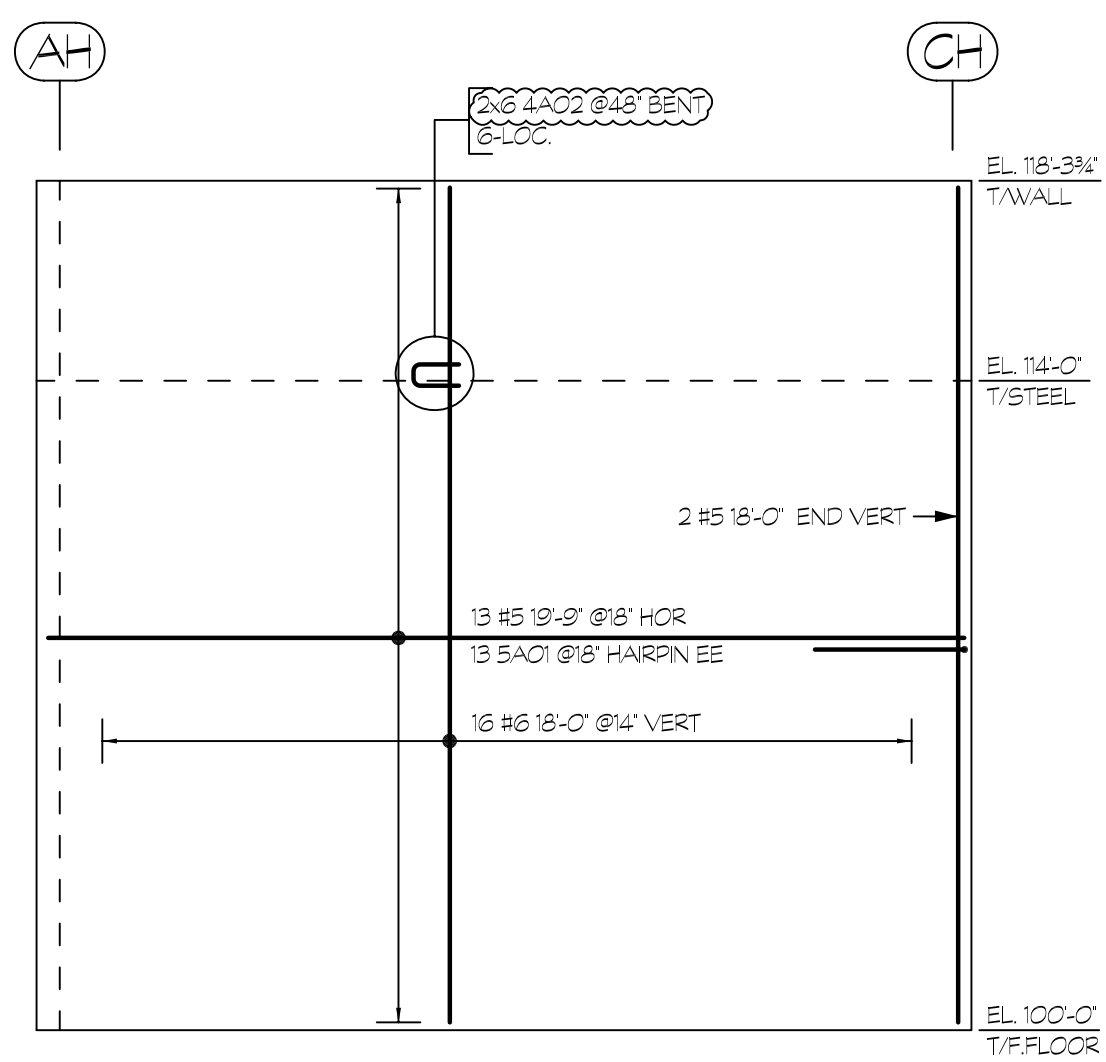

SECTION THICKNESS
ELEVATION AE
SCALE 1/4\"/>

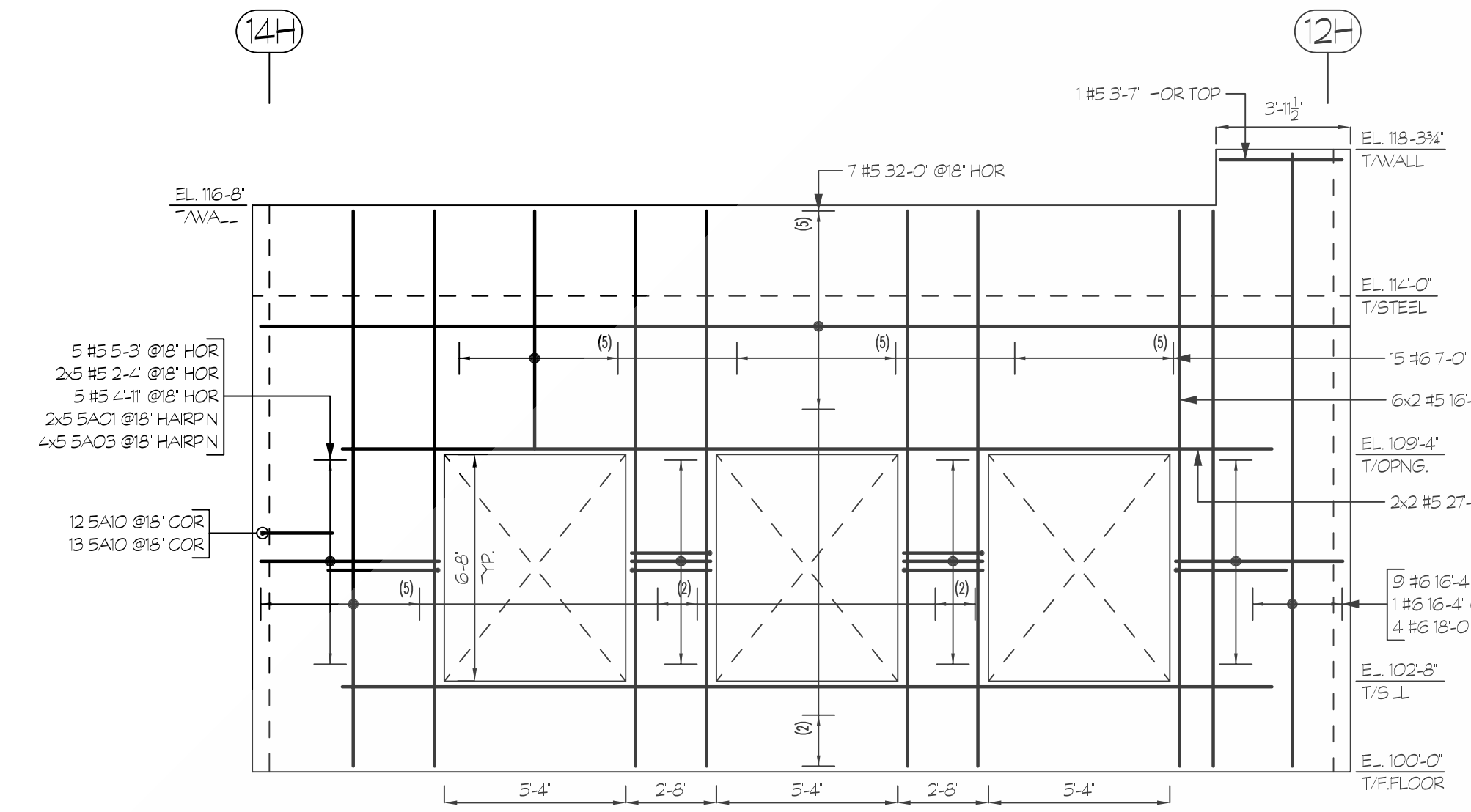

SECTION THICKNESS
ELEVATION AF
SCALE 1/4\"/>

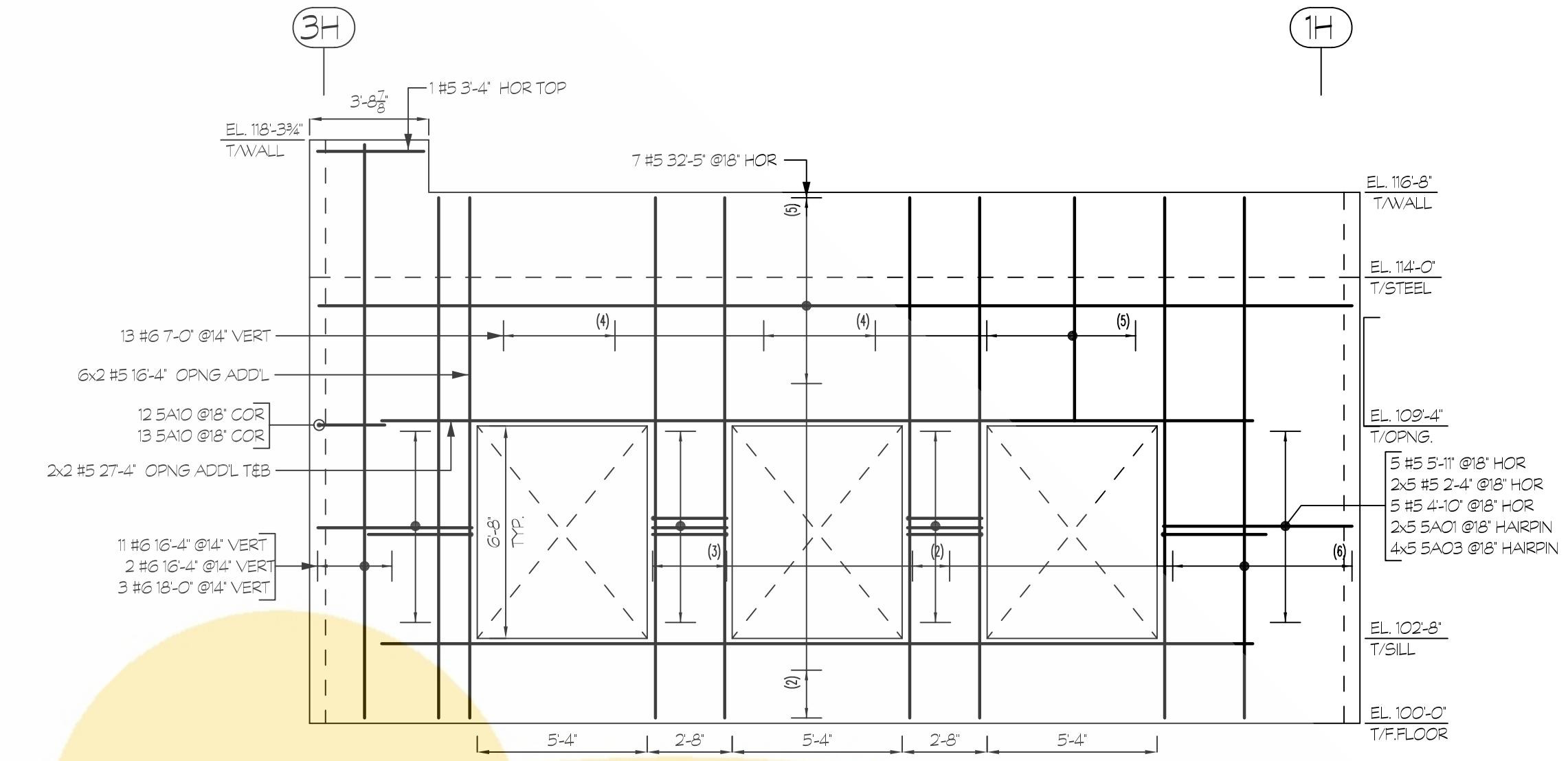

SECTION THICKNESS
ELEVATION AK
SCALE 1/4\"/>

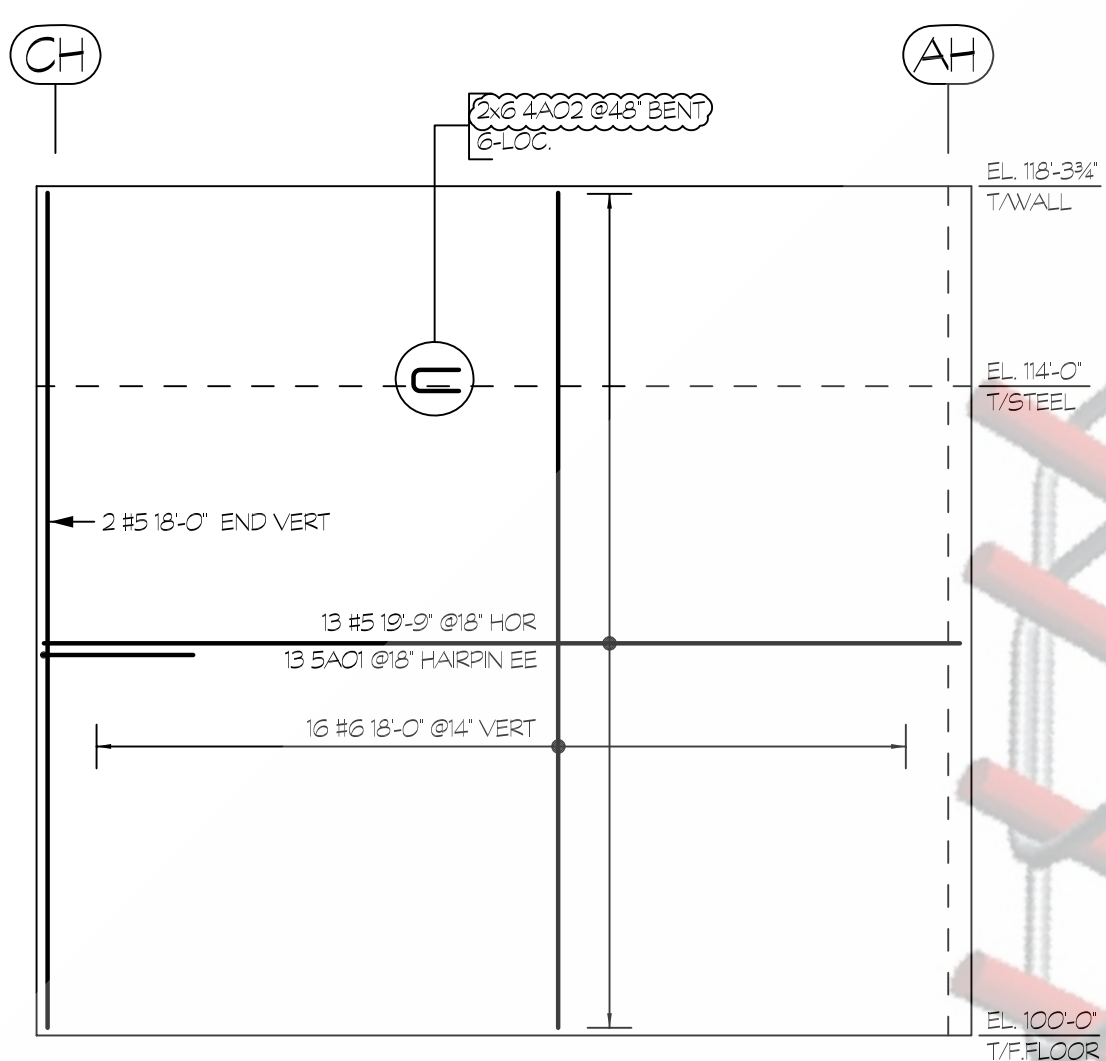

SECTION THICKNESS
ELEVATION AL
SCALE 1/4\"/>

Release Number: R1.01-R1.12

		BENDING DETAILS														
Bar Mark	Qty	Size	Total Length	Type	'A'	'B'	'C'	'D'	'E'	'F'	'G'	'H'	'J'	'K'	'O'	'R'
4A01	112	#4	4'-6"	17		2'-0"	0'-6"	2'-0"								
4A02	48	#4	2'-6"	17		1'-0"	0'-6"	1'-0"								
5A01	1018	#5	6'-11"	17		3'-3"	0'-5"	3'-3"								
5A02	10	#5	4'-5"	17		2'-0"	0'-5"	2'-0"								
5A03	130	#5	5'-1"	17		2'-4"	0'-5"	2'-4"								
5A04	150	#5	3'-9"	17		1'-8"	0'-5"	1'-8"								
5A05	10	#5	6'-7"	17		3'-1"	0'-5"	3'-1"								
5A06	165	#5	6'-5"	17		3'-0"	0'-5"	3'-0"								
5A07	14	#5	1'-11"	17		0'-9"	0'-5"	0'-9"								
5A08	10	#5	3'-1"	17		1'-4"	0'-5"	1'-4"								
5A09	50	#5	2'-5"	17		1'-0"	0'-5"	1'-0"								
5A10	349	#5	4'-2"	17		2'-1"	2'-1"									

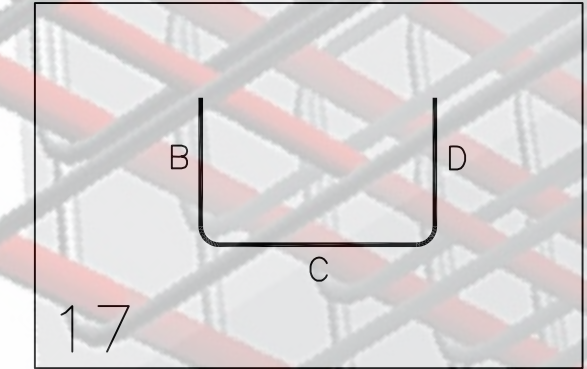

BAR SIZE	3000 PSI	
	TOP	OTHERS
#3	28	22
#4	37	29
#5	47	36
#6	56	43
#7	81	63
#8	93	72

ONCE REBAR SERVICES